

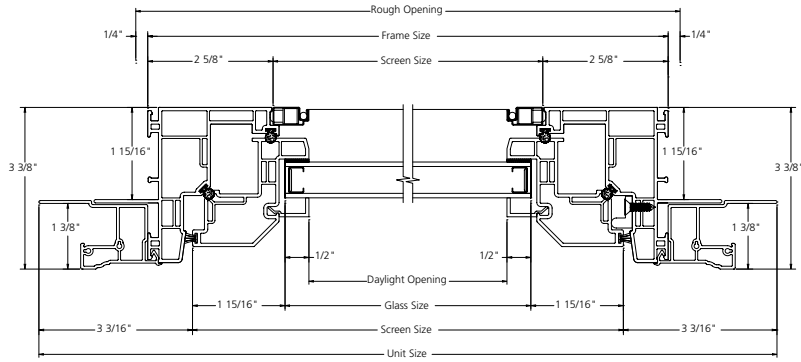

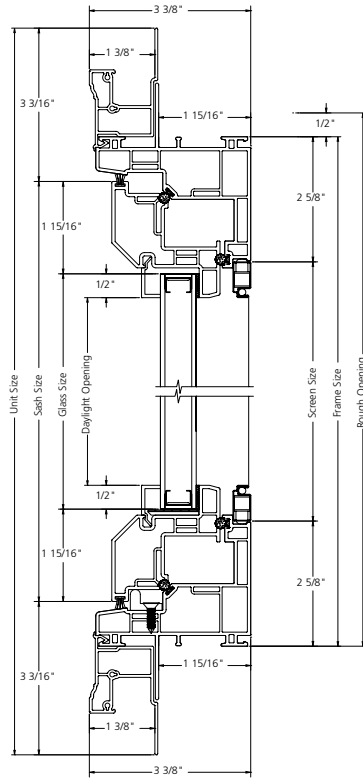











































CASEMENT VERTICAL AND HORIZONTAL SECTION DETAILS



FULL CASEMENT UNITS

Rough Opening Frame Size	18" 17 1/2"	24" 23 1/2"	28" 27 1/2"	30" 29 1/2"	36" 35 1/2"
24" 23 1/2"	 FCV1824	 FCV2424	 FCV2824	 FCV3024	 FCV3624
30" 29 1/2"	 FCV1830	 FCV2430	 FCV2830	 FCV3030	 FCV3630
36" 35 1/2"	 FCV1836	 FCV2436	 FCV2836	 FCV3036	 FCV3636
42" 41 1/2"	 FCV1842	 FCV2442	 FCV2842	 FCV3042	 FCV3642
48" 47 1/2"	 FCV1848	 FCV2448	 FCV2848	 FCV3048	 FCV3648
54" 53 1/2"	 FCV1854	 FCV2454	 FCV2854	 FCV3054	 FCV3654
60" 59 1/2"	 FCV1860	 FCV2460	 FCV2860	 FCV3060	 FCV3660
66" 65 1/2"	 FCV1866	 FCV2466	 FCV2866	 FCV3066	 FCV3666
72" 71 1/2"	 FCV1872	 FCV2472	 FCV2872	 FCV3072	 FCV3672

CASEMENT

Note: Standard grid patterns are shown.

ELEVATION SYMBOL LEGEND

"E" unit meets egress requirements for BOCA code. State and local egress codes may differ. Always refer to local building codes for complete requirements. Check with local officials to ensure compliance before installing the unit.