

ROLLER SECTION DETAILS
NAILING FIN

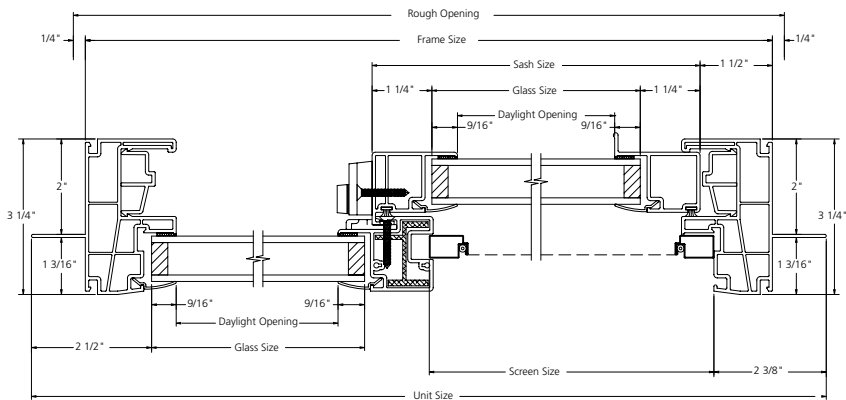

ROLLER SECTION DETAILS
FLANGE

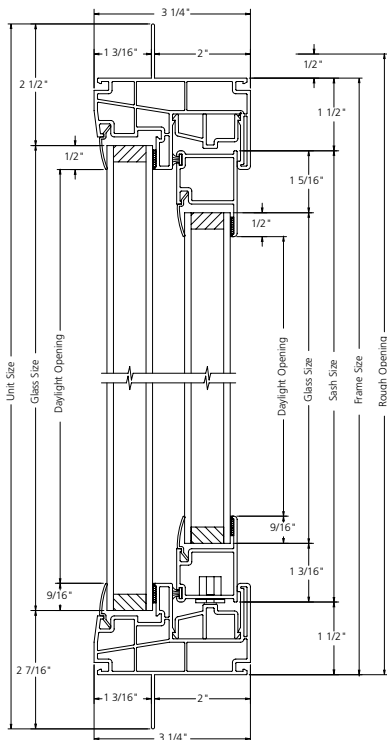

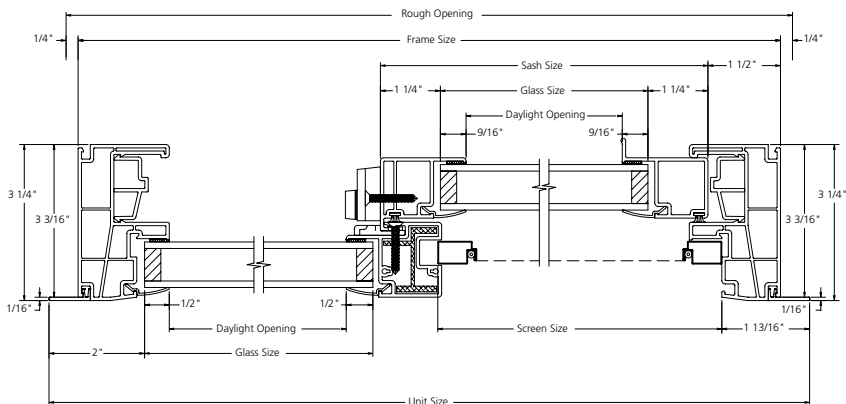
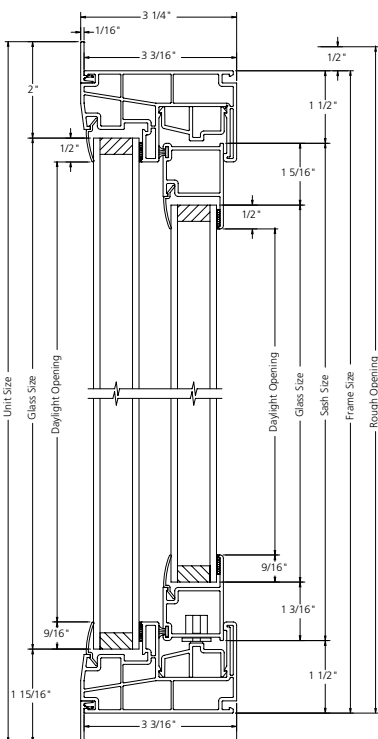



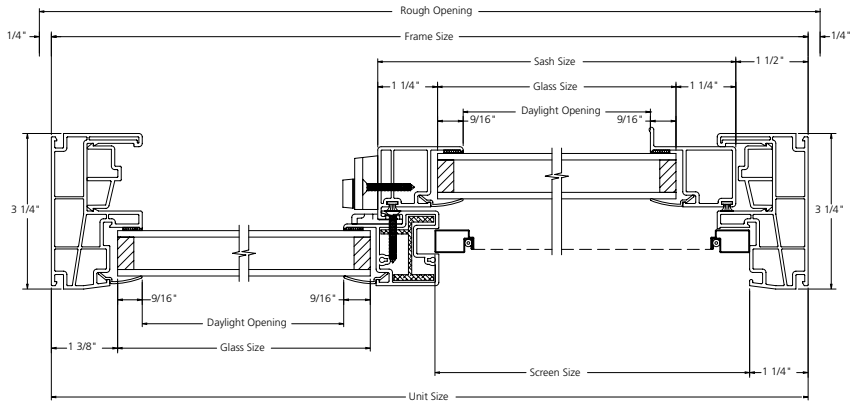
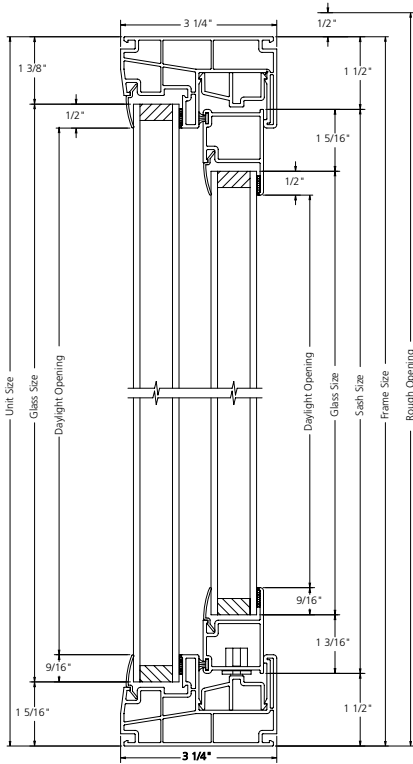





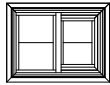
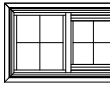
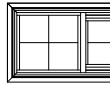
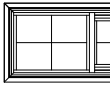
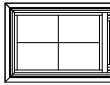
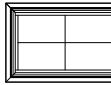
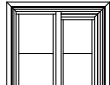

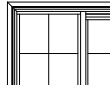
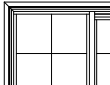



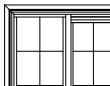







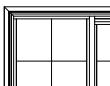





ROLLER

ROLLER SECTION DETAILS POCKET

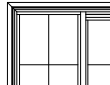
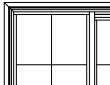

ROLLER

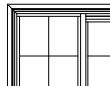
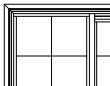
ROLLER UNITS

Rough Opening Frame Size	24" 23 1/2"	30" 29 1/2"	36" 35 1/2"	42" 41 1/2"	48" 47 1/2"	54" 53 1/2"
18" 17 1/2"	 8RW2418	 8RW3018	 8RW3618	 8RW4218	 8RW4818	 8RW5418
24" 23 1/2"	 8RW2424	 8RW3024	 8RW3624	 8RW4224	 8RW4824	 8RW5424
30" 29 1/2"	 8RW2430	 8RW3030	 8RW3630	 8RW4230	 8RW4830	 8RW5430
36" 35 1/2"	 8RW2436	 8RW3036	 8RW3636	 8RW4236	 8RW4836	 8RW5436
38" 37 1/2"	 8RW2438	 8RW3038	 8RW3638	 8RW4238	 8RW4838	 8RW5438
42" 41 1/2"	 8RW2442	 8RW3042	 8RW3642	 8RW4242	 8RW4842	 8RW5442
44" 43 1/2"	 8RW2444	 8RW3044	 8RW3644	 8RW4244	 8RW4844	 8RW5444

ROLLER

ELEVATION SYMBOL LEGEND

E BASIC UNIT CLEAR OPENING EXCEEDS 20" IN WIDTH, 24" IN HEIGHT & A MINIMUM OF 5.7 SQ. FT.

ROLLER WINDOWS

ROLLER UNITS (CONTINUED)

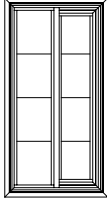
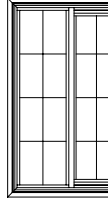
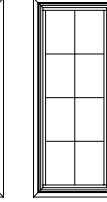
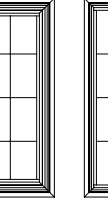
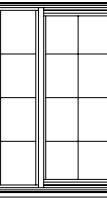
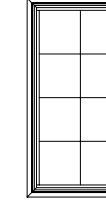
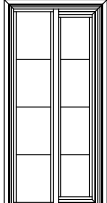
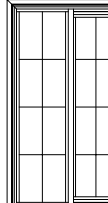
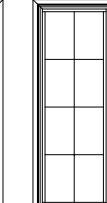
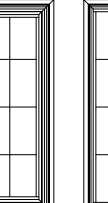
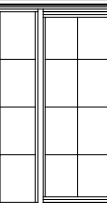
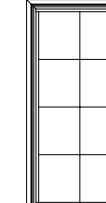
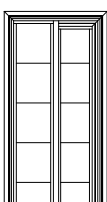
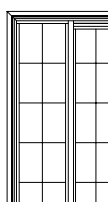
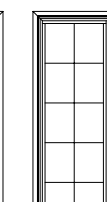
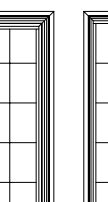
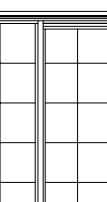
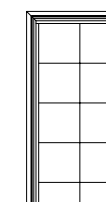
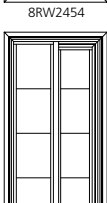
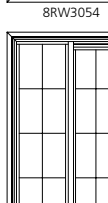
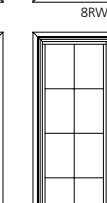
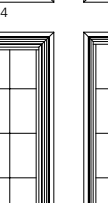
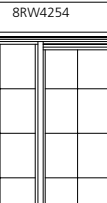
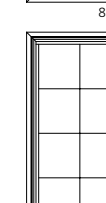
Rough Opening Frame Size	24" 23 1/2"	30" 29 1/2"	36" 35 1/2"	42" 41 1/2"	48" 47 1/2"	54" 53 1/2"
48" 47 1/2"	 8RW2448	 8RW3048	 8RW3648	 8RW4248	 8RW4848	 8RW5448
52" 51 1/2"	 8RW2452	 8RW3052	 8RW3652	 8RW4252	 8RW4852	 8RW5452
54" 53 1/2"	 8RW2454	 8RW3054	 8RW3654	 8RW4254	 8RW4854	 8RW5454
60" 59 1/2"	 8RW2460	 8RW3060	 8RW3660	 8RW4260	 8RW4860	 8RW5460

ROLLER

ELEVATION SYMBOL LEGEND

- E BASIC UNIT CLEAR OPENING EXCEEDS 20" IN WIDTH, 24" IN HEIGHT & A MINIMUM OF 5.7 SQ. FT.

ROLLER UNITS (CONTINUED)

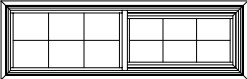
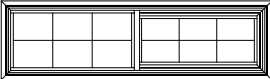
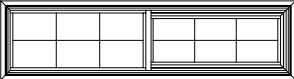
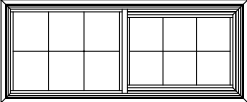
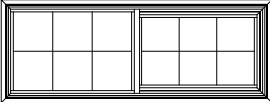
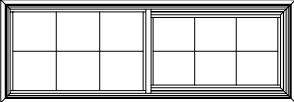
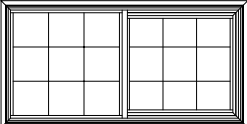
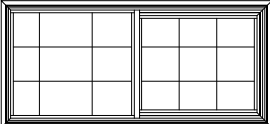
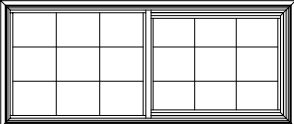
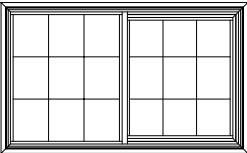
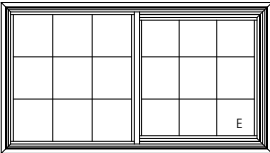
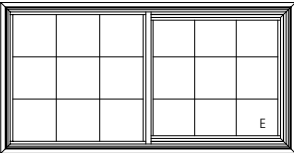
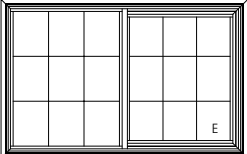
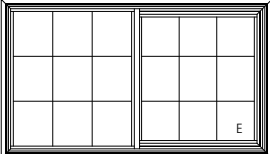
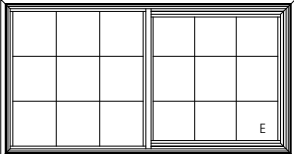
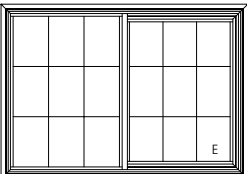
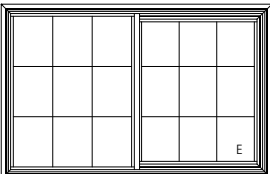
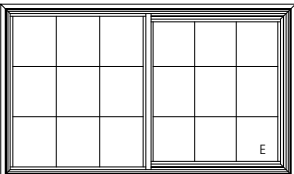
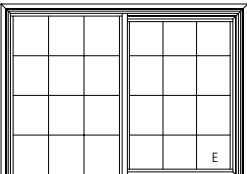
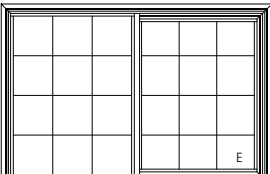
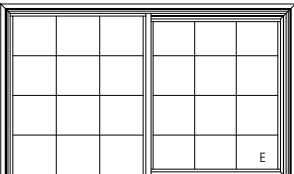
Rough Opening Frame Size	60" 59 1/2"	66" 65 1/2"	72" 71 1/2"
18" 17 1/2"	 8RW6018	 8RW6618	 8RW7218
24" 23 1/2"	 8RW6024	 8RW6624	 8RW7224
30" 29 1/2"	 8RW6030	 8RW6630	 8RW7230
36" 35 1/2"	 8RW6036	 8RW6636	 8RW7236
38" 37 1/2"	 8RW6038	 8RW6638	 8RW7238
42" 41 1/2"	 8RW6042	 8RW6642	 8RW7242
44" 43 1/2"	 8RW6044	 8RW6644	 8RW7244

ROLLER

ELEVATION SYMBOL LEGEND

E BASIC UNIT CLEAR OPENING EXCEEDS 20" IN WIDTH, 24" IN HEIGHT & A MINIMUM OF 5.7 SQ. FT.

ROLLER WINDOWS

ROLLER UNITS (CONTINUED)

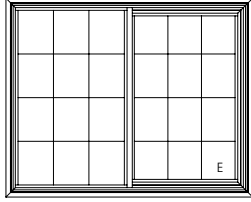
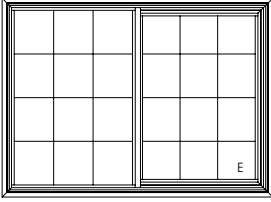
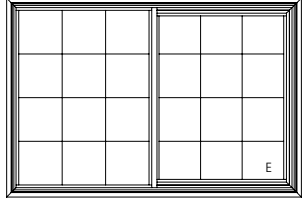
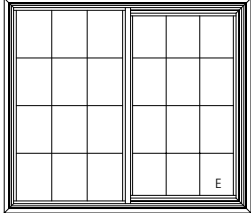
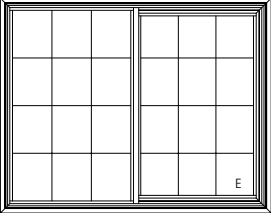
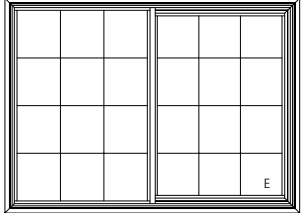
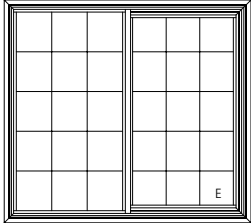
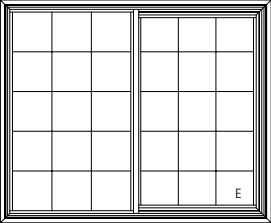
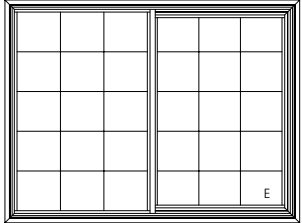
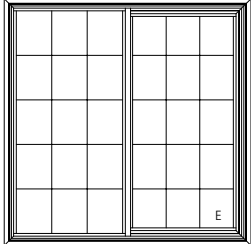
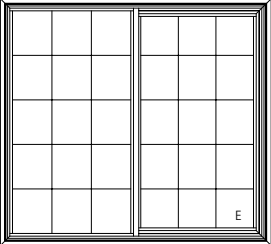
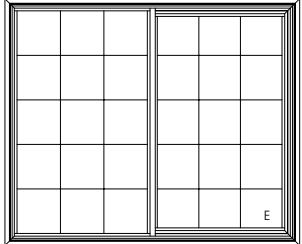
	Rough Opening Frame Size	60" 59 1/2"	66" 65 1/2"	72" 71 1/2"
48" 47 1/2"				
	8RW6048	8RW6648	8RW7248	
52" 51 1/2"				
	8RW6052	8RW6652	8RW7252	
54" 53 1/2"				
	8RW6054	8RW6654	8RW7254	
60" 59 1/2"				
	8RW6060	8RW6660	8RW7260	

ROLLER

ELEVATION SYMBOL LEGEND

- E BASIC UNIT CLEAR OPENING EXCEEDS 20" IN WIDTH, 24" IN HEIGHT & A MINIMUM OF 5.7 SQ. FT.

ROLLER UNITS - FLORIDA SIZES

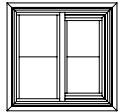
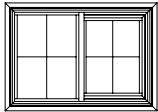
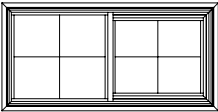
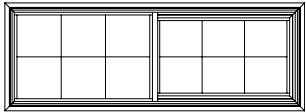
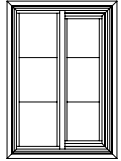
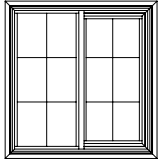
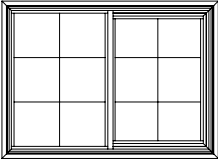
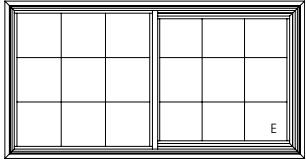
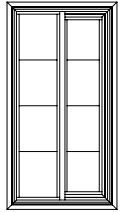
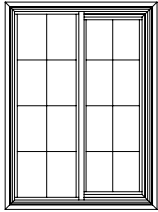
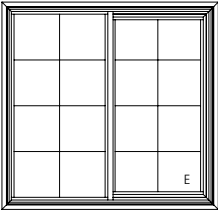
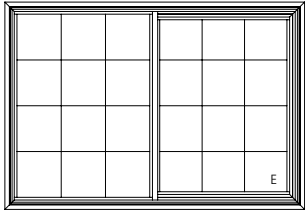
	Rough Opening Frame Size	24 3/4" 24 1/4"	36 1/4" 35 3/4"	52 3/8" 51 7/8"	73 1/4" 72 3/4"
25 1/4" 24 3/4"					
37 5/8" 37 1/8"				 E	
49 7/8" 49 3/8"			 E	 E	

ROLLER

ELEVATION SYMBOL LEGEND

E BASIC UNIT CLEAR OPENING EXCEEDS 20" IN WIDTH, 24" IN HEIGHT & A MINIMUM OF 5.7 SQ. FT.