

CASEMENT SECTION DETAILS
NAILING FIN

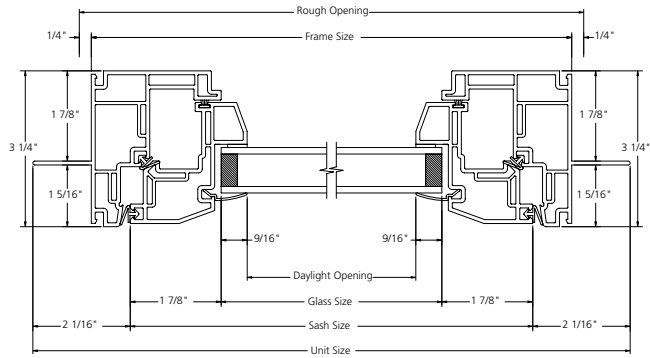

CASEMENT SECTION DETAILS
FLANGE

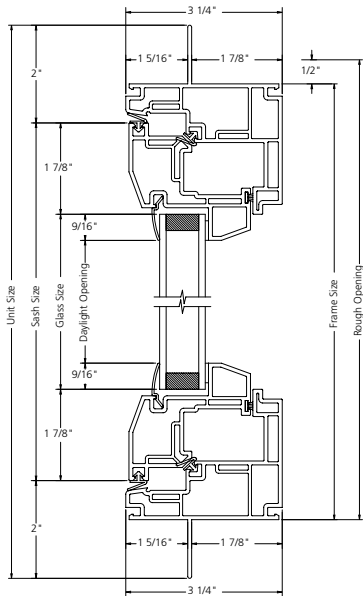
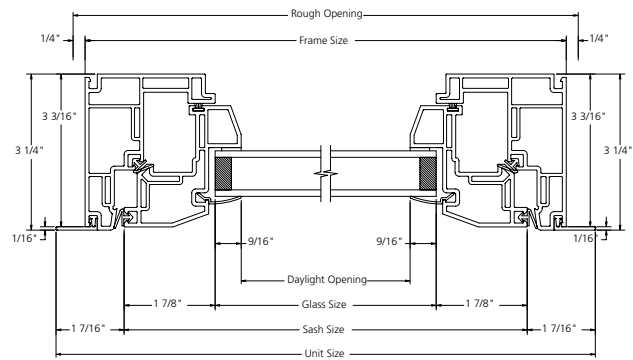
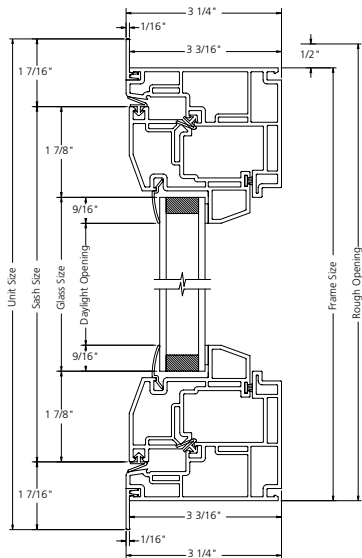

CASEMENT SECTION DETAILS POCKET

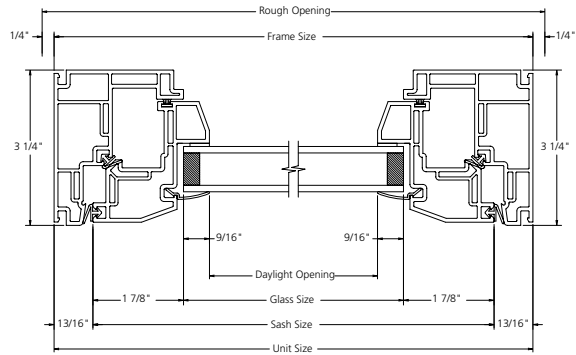
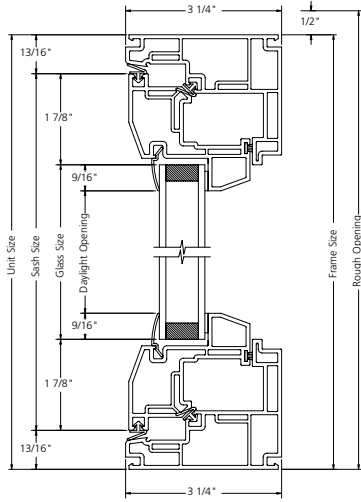

FULL CASEMENT UNITS

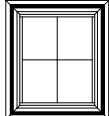
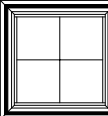
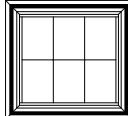
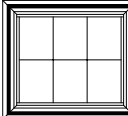
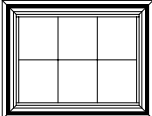
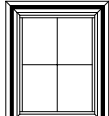
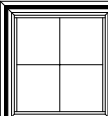
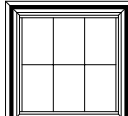
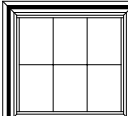
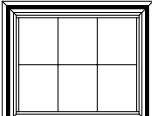
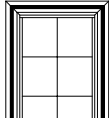
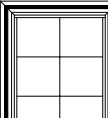
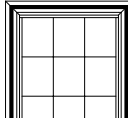
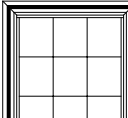
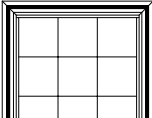
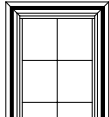
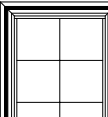
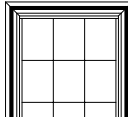
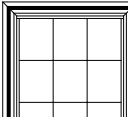
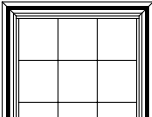
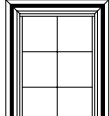
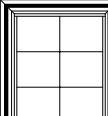
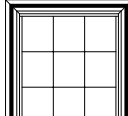
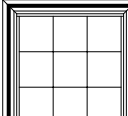
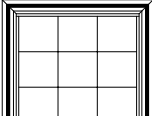
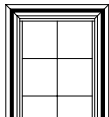
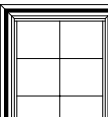
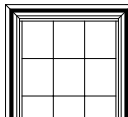
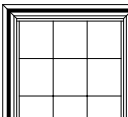
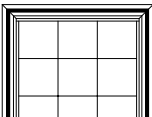
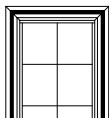
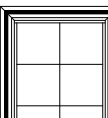
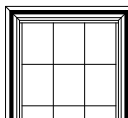
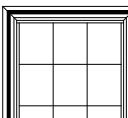
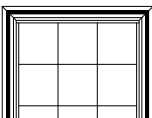
Rough Opening Frame Size	24" 23 1/2"	28" 27 1/2"	30" 29 1/2"	32" 31 1/2"	36" 35 1/2"
28" 27 1/2"	 8CMT2428	 8CMT2828	 8CMT3028	 8CMT3228	 8CMT3628
30" 29 1/2"	 8CMT2430	 8CMT2830	 8CMT3030	 8CMT3230	 8CMT3630
36" 35 1/2"	 8CMT2436	 8CMT2836	 8CMT3036	 8CMT3236	 8CMT3636
38" 37 1/2"	 8CMT2438	 8CMT2838	 8CMT3038	 8CMT3238	 8CMT3638
42" 41 1/2"	 8CMT2442	 8CMT2842	 8CMT3042	 8CMT3242	 8CMT3642
44" 43 1/2"	 8CMT2444	 8CMT2844	 8CMT3044	 8CMT3244	 8CMT3644
48" 47 1/2"	 8CMT2448	 8CMT2848	 8CMT3048	 8CMT3248	 8CMT3648

CASEMENT









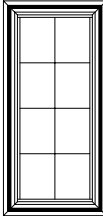
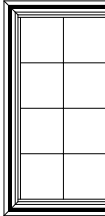
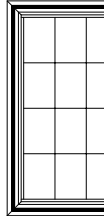
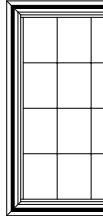
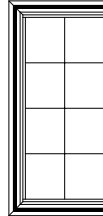
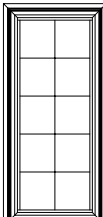
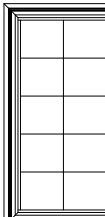
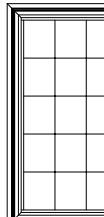
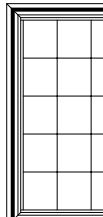
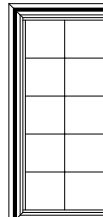
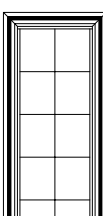
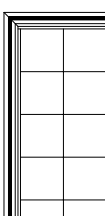
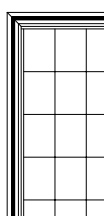

ELEVATION SYMBOL LEGEND

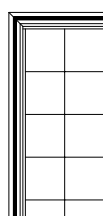
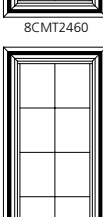
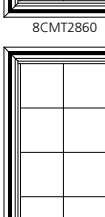
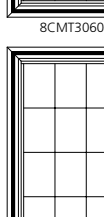
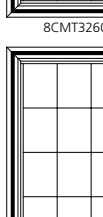
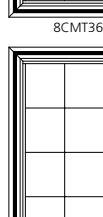
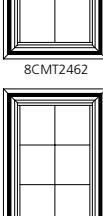
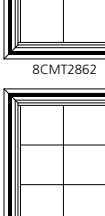
E BASIC UNIT CLEAR OPENING EXCEEDS 20" IN WIDTH, 24" IN HEIGHT & A MINIMUM OF 5.7 SQ. FT.

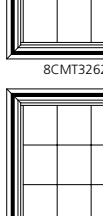
CASEMENT WINDOWS

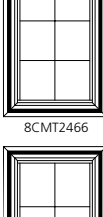
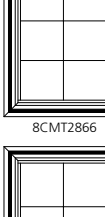
FULL CASEMENT UNITS (CONTINUED)

CASEMENT

Rough Opening Frame Size	24" 23 1/2"	28" 27 1/2"	30" 29 1/2"	32" 31 1/2"	36" 35 1/2"
52" 51 1/2"	 8CMT2452	 8CMT2852	 8CMT3052	 8CMT3252	 8CMT3652
54" 53 1/2"	 8CMT2454	 8CMT2854	 8CMT3054	 8CMT3254	 8CMT3654
60" 59 1/2"	 8CMT2460	 8CMT2860	 8CMT3060	 8CMT3260	 8CMT3660
62" 61 1/2"	 8CMT2462	 8CMT2862	 8CMT3062	 8CMT3262	 8CMT3662
66" 65 1/2"	 8CMT2466	 8CMT2866	 8CMT3066	 8CMT3266	 8CMT3666
72" 71 1/2"	 8CMT2472	 8CMT2872	 8CMT3072	 8CMT3272	 8CMT3672

ELEVATION SYMBOL LEGEND

E BASIC UNIT CLEAR OPENING EXCEEDS 20" IN WIDTH, 24" IN HEIGHT & A MINIMUM OF 5.7 SQ. FT.

FULL CASEMENT UNITS - FLORIDA SIZES

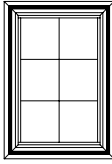
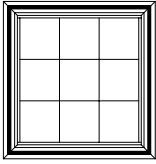
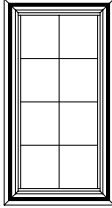
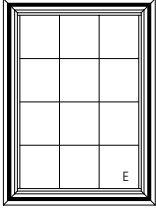
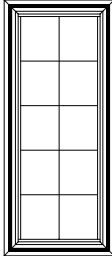
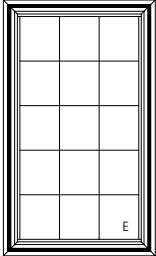
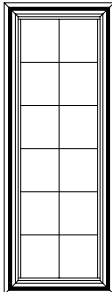
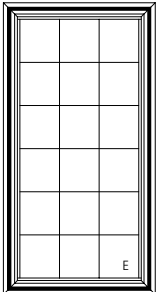
	Rough Opening Frame Size	25 3/4" 25 1/4"	36 1/4" 35 3/4"
37 5/8" 37 1/8"		 8CMT-H33	 8CMT-23
49 7/8" 49 3/8"		 8CMT-H34	 8CMT-24
62 1/4" 61 3/4"		 8CMT-H35	 8CMT-25
71 1/4" 70 3/4"		 8CMT-H36S	 8CMT-26S

ELEVATION SYMBOL LEGEND

- E BASIC UNIT CLEAR OPENING EXCEEDS 20" IN WIDTH, 24" IN HEIGHT & A MINIMUM OF 5.7 SQ. FT.