

QUICK SPEC GUIDE

CLAD FIXED RADIUS

SPECIFICATION	STANDARD FEATURES	OPTIONAL FEATURES <i>Some options may require additional lead times. Consult your JELD-WEN Sales Representative.</i>
EXTERIOR FINISH	<ul style="list-style-type: none"> S Brilliant White S Chestnut Bronze S Desert Sand S French Vanilla S Mesa Red S Hartford Green S Black S Artic Silver S Dark Chocolate 	
INTERIOR FINISH	<ul style="list-style-type: none"> S Natural 	<ul style="list-style-type: none"> S Primed or Painted White Finish S Stain - Fruitwood and Cider
SIZE	<ul style="list-style-type: none"> S Width: Standard Width & Heights to align with windows & patio doors 24, 26, 28, 24/36, 30, 32, 34 	<ul style="list-style-type: none"> S Width: 12 to 96* in 1/8" increments S Height: 9 to 96* in 1/8" increments *some restrictions by shape
GLAZING	<ul style="list-style-type: none"> S Low-E Insulating Glass S Preserve® Protective Film 	<ul style="list-style-type: none"> S Clear S Obscure S Low-E 366 S Neat Glass S Dual Low-E S Tints: Bronze, Gray, Green S Reflective Tints: Bronze, Gray S Tempered
GRILLES		<ul style="list-style-type: none"> S 7/8", 1-1/8" and 1-3/8" Removable Interior Grilles S 7/8", 1-1/8" and 1-3/8" Removable Full-Surround S 7/8" Removable Interior Vinyl Grille S 5/8" Flat; 22/32" and 1" Profiled GBG 7/8", 1-1/8", 1-3/8" and 2-1/8" SDL options: S 7/8", 1-1/8", 1-3/8" SDL with Removable Interior Full-Surround Wood Grille S 7/8", 1-1/8", 1-3/8" SDL with Permanently Applied Interior Wood Grille & Silver Shadow Bar S 2-1/8" Simulated Checkrail
EXTERIOR TRIMS	<ul style="list-style-type: none"> S Drip Cap with Nailing Fin 	<ul style="list-style-type: none"> S Aluminum Brickmould S Adams Casing - 3-7/32" wide
INTERIOR TRIM	<ul style="list-style-type: none"> S 2-1/4" Width Pine S WM 366, 356, 327 	<ul style="list-style-type: none"> S 2-1/4" Width Oak S Custom Profiles available in Pine
JAMB	<ul style="list-style-type: none"> S 4-9/16" 	<ul style="list-style-type: none"> S Minimum: 2-1/2" S Maximum: 7-1/4" one piece S Maximum: 10-9/16" two piece

Note: All measurements are in inches.

QUICK SPEC GUIDE

CLAD OPERATING RADIUS

SPECIFICATION	STANDARD FEATURES	OPTIONAL FEATURES <i>Some options may require additional lead times. Consult your JELD-WEN Sales Representative.</i>
EXTERIOR FINISH	<ul style="list-style-type: none"> § Brilliant White § Chestnut Bronze § Desert Sand § French Vanilla § Mesa Red § Hartford Green 	
INTERIOR FINISH	<ul style="list-style-type: none"> § Natural 	<ul style="list-style-type: none"> § Primed or Painted White Finish § Stain - Fruitwood and Cider
SIZE	<ul style="list-style-type: none"> § Width: Segment Head Double-Hung & True Radius Single-Hung 29-3/8, 33-3/8, 37-3/8, 41-3/8 § Height: Segment Head Double-Hung 56, 64, 68**, 76 § Height: True Radius Single-Hung 58-3/8, 66-3/8, 70-3/8**, 78-3/8 <p>**reverse cottage sash</p>	<ul style="list-style-type: none"> § Special Widths not available § Height: 54 to 78 in 1/8" increments § Height: 58-3/8 to 78-3/8 in 1/8" increments
GLAZING	<ul style="list-style-type: none"> § Low-E Insulating Glass § Preserve® Protective Film 	<ul style="list-style-type: none"> § Clear § Obscure § Low-E 366 § Neat Glass § Dual Low-E § Tints: Bronze, Gray, Green § Reflective Tints: Bronze, Gray § Tempered
		<ul style="list-style-type: none"> § High Altitude
HARDWARE	<ul style="list-style-type: none"> § Cam Lock § 2 Locks 3'0" and wider 	
HARDWARE COLOR	<ul style="list-style-type: none"> § Chestnut Bronze 	<ul style="list-style-type: none"> § White § Bright Brass § Desert Sand
SCREENS	<ul style="list-style-type: none"> § BetterVue^t 	<ul style="list-style-type: none"> § Aluminum Mesh § Fiberglass
SCREEN FRAME COLOR	<ul style="list-style-type: none"> § Color Match Clad 	
GRILLES		<ul style="list-style-type: none"> § 7/8", 1-1/8" and 1-3/8" Removable Interior Grilles § 7/8", 1-1/8" and 1-3/8" Removable Full-Surround § 5/8" Flat; 22/32" and 1" Profiled GBG 7/8", 1-1/8", 1-3/8" and 2-1/8" SDL options: § 7/8", 1-1/8", 1-3/8" SDL with Removable Interior Full-Surround Wood Grille § 7/8", 1-1/8", 1-3/8" SDL with Permanently Applied Interior Wood Grille & Silver Shadow Bar § 2-1/8" Simulated Checkrail
EXTERIOR TRIMS	<ul style="list-style-type: none"> § Drip Cap with Nailing Fin 	<ul style="list-style-type: none"> § Aluminum Brickmould § Adams Casing - 3-7/32" wide
JAMB	<ul style="list-style-type: none"> § 4-9/16" 	<ul style="list-style-type: none"> § Minimum: 4-9/16" § Maximum: 9-1/4" one piece § Maximum: 10-9/16" two piece

Note: All measurements are in inches.

QUICK SPEC GUIDE

CLAD GEOMETRIC

SPECIFICATION	STANDARD FEATURES	OPTIONAL FEATURES <i>Some options may require additional lead times. Consult your JELD-WEN Sales Representative.</i>
EXTERIOR FINISH	<ul style="list-style-type: none"> S Brilliant White S Chestnut Bronze S Desert Sand S French Vanilla S Mesa Red S Hartford Green S Black S Artic Silver S Dark Chocolate 	
INTERIOR FINISH	<ul style="list-style-type: none"> S Natural 	<ul style="list-style-type: none"> S Primed or Painted White Finish S Stain - Fruitwood and Cider
SIZE	<ul style="list-style-type: none"> S Width: 9" to 120" (1/8" increments)* S Height: 9" to 120" (1/8" increments)* <p>*see pages 9-17 and 9-18 for limitations</p>	
GLAZING	<ul style="list-style-type: none"> S Low-E Insulating Glass S Preserve® Protective Film 	<ul style="list-style-type: none"> S Clear S Obscure S Low-E 366 S Neat Glass S Dual Low-E S Tints: Bronze, Gray, Green S Reflective Tints: Bronze, Gray S Tempered
GRILLES		<ul style="list-style-type: none"> S High Altitude S 7/8", 1-1/8" and 1-3/8" Removable Interior Grilles S 7/8", 1-1/8" and 1-3/8" Removable Full-Surround S 7/8" Removable Interior Vinyl Grille S 5/8" Flat; 22/32" and 1" Profiled GBG 7/8", 1-1/8", 1-3/8" and 2-1/8" SDL options: S 7/8", 1-1/8", 1-3/8" SDL with Removable Interior Full-Surround Wood Grille S 7/8", 1-1/8", 1-3/8" SDL with Permanently Applied Interior Wood Grille & Silver Shadow Bar S 2-1/8" Simulated Checkrail
EXTERIOR TRIMS	<ul style="list-style-type: none"> S Integral Nailing Fin 	<ul style="list-style-type: none"> S No Nail Fin S Aluminum Brickmould S Adams or Flat Casing - 3-7/32" wide
JAMB	<ul style="list-style-type: none"> S Applied 4-9/16" 	<ul style="list-style-type: none"> S Minimum: 2-1/2" S Maximum: 7-1/4" one piece S Maximum: 10-9/16" two piece

Note: All measurements are in inches.

FIXED RADIUS CUSTOM SIZING GUIDELINES

DIMENSIONS REQUIRED FOR STANDARD UNITS

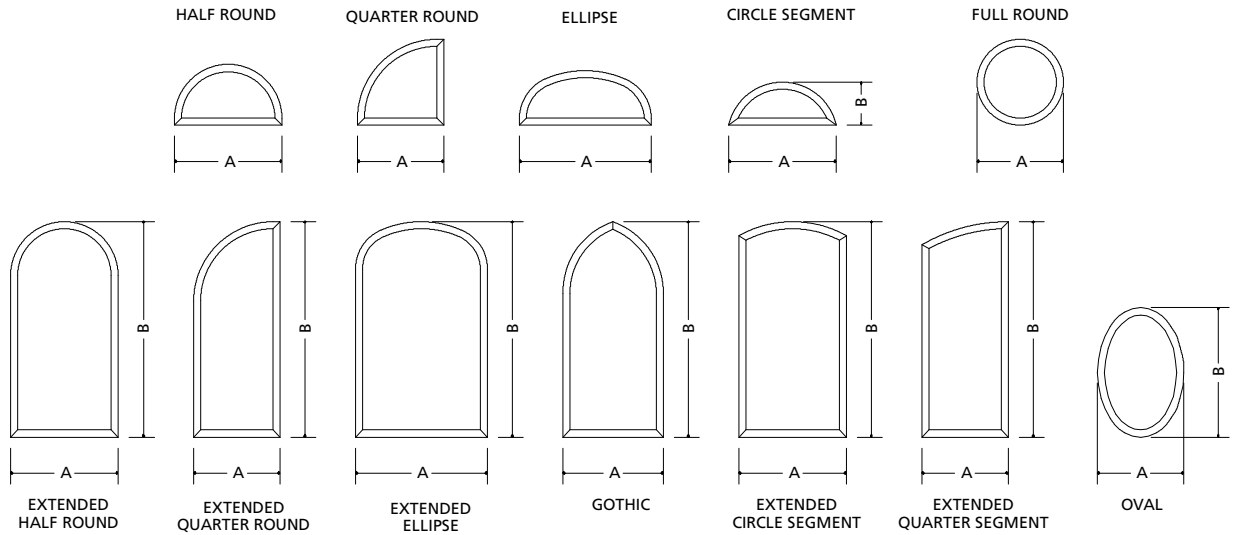

SIZE LIMITATIONS

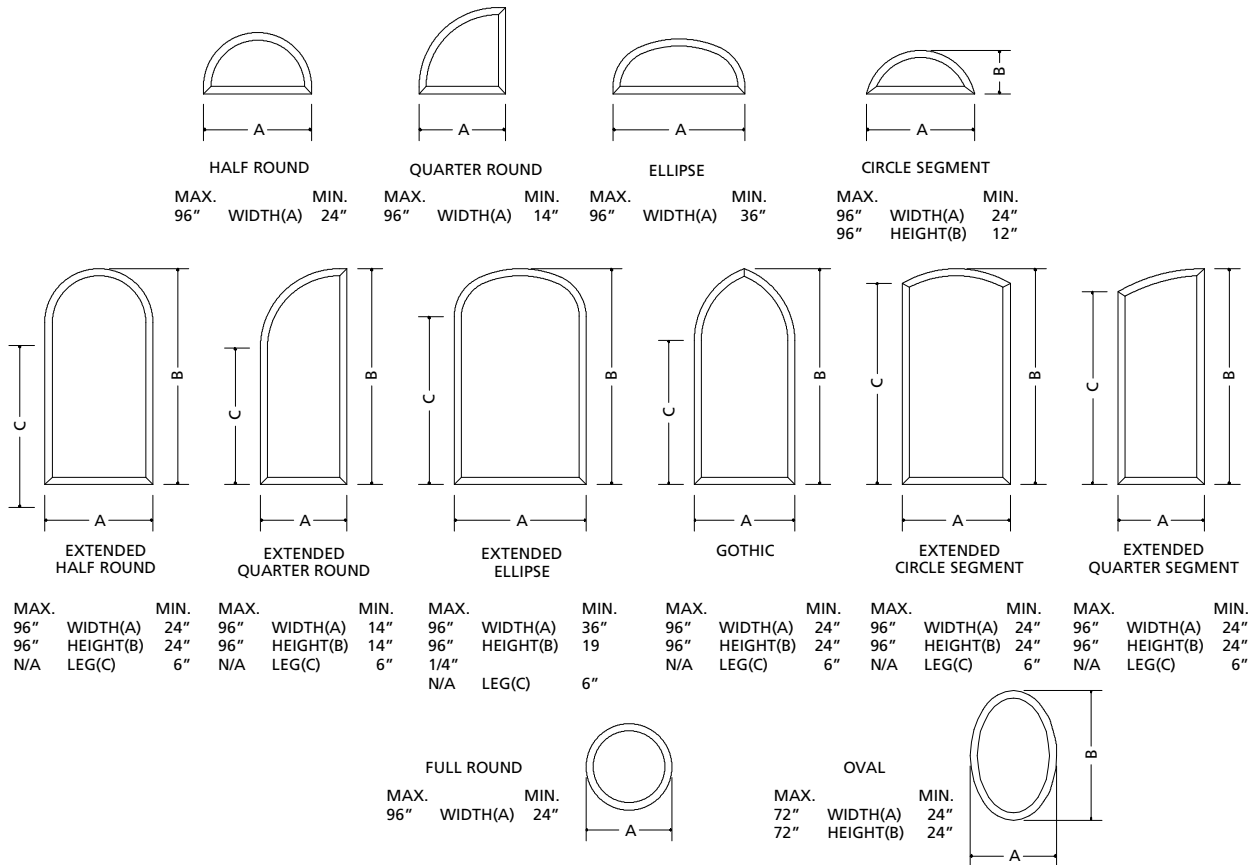

NOTE: Maximum square footage for one unit is 49 square feet.

Note: All measurements are in inches.

FIXED RADIUS DIMENSION CONVERSION CHART

To calculate rough opening, exterior casing or glass dimensions, add or subtract the appropriate dimension from below to the overall frame dimension.

		Width	Height
Rough Opening Dimension	Add	3/4"	1/2"
Aluminum Adams/Flat Casing Dimension	Add	5-13/16"	4"
Aluminum Brickmould Dimension	Add	2-3/4"	2-1/2"
Glass Dimension	Subtract	3"	3"
Glass Dimension (Tradition Plus)	Subtract	2-7/16"	2-7/16"
Glass Dimension (SmartFit [®])	Subtract	1-1/2"	1-1/2"

Full-Surround Grilles cannot be ordered separate from the unit. To ensure proper fit, they must be ordered at the same time as the unit.

EXAMPLE CUSTOM RADIUS GRILLES

FULL ROUNDS

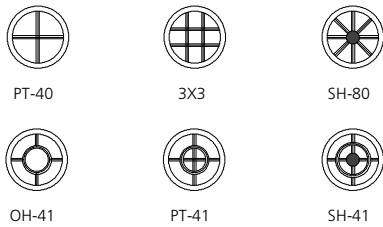

QUARTER ROUNDS

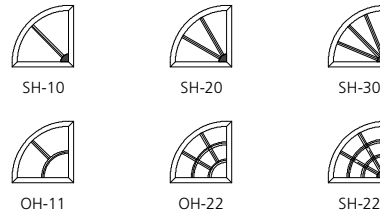

ROUND TOPS

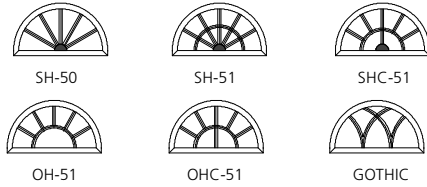

ELLIPTICAL TOPS

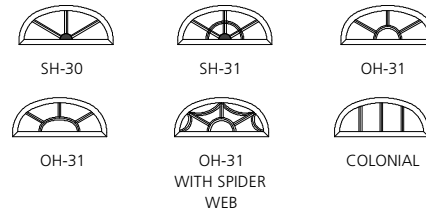

OVALS

Patterns shown below are available in removable wood grilles.



SEGMENT HEADS

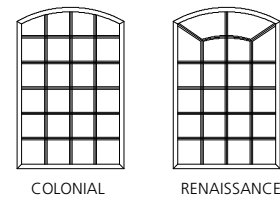

Patterns shown below are available in simulated divided lites (SDL) and grilles between the glass.



STANDING ARCHES

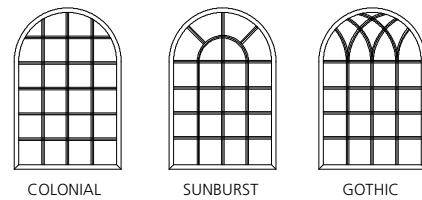

Note: Lite patterns not available with with all divided lite options.

Note: All measurements are in inches.

FIXED RADIUS CURVED INTERIOR CASING

STANDARD INTERIOR WOOD CURVED CASING PROFILES

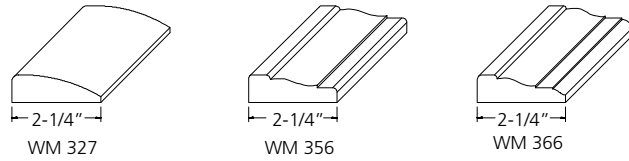

STANDARD INTERIOR WOOD CURVED CASING PROFILES

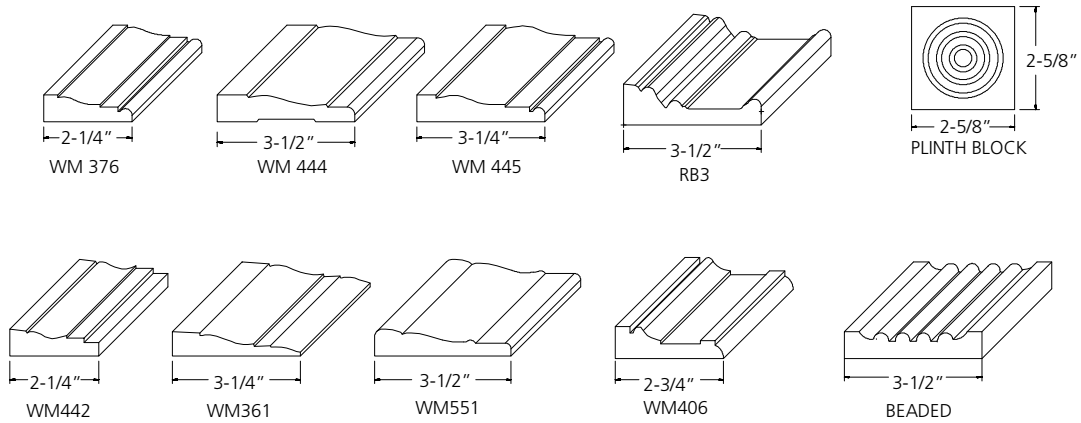

Note: All measurements are in inches.

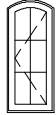

OPERATING RADIUS - SEGMENT HEAD CASEMENT

Bookcodebd	Sizing		SqFt	LinFt	Divided Lites
	Frame Size	Rough Opening			Lite Pattern
CSCU1-2040	24 X 48	24-3/4 X 48-3/4	8.00	12.00	2W4H
CSCU1-2050	24 X 60	24-3/4 X 60-3/4	10.00	14.00	2W5H
CSCU1-2054	24 X 64	24-3/4 X 64-3/4	10.67	14.67	2W5H
CSCU1-2060	24 X 72	24-3/4 X 72-3/4	12.00	16.00	2W6H
CSCU1-2640	30 X 48	30-3/4 X 48-3/4	10.00	13.00	3W4H
CSCU1-2650	30 X 60	30-3/4 X 60-3/4	12.50	15.00	3W5H
CSCU1-2654	30 X 64	30-3/4 X 64-3/4	13.33	15.67	3W5H
CSCU1-2660	30 X 72	30-3/4 X 72-3/4	15.00	17.00	3W6H
CSCU1-3440	40 X 48	40-3/4 X 48-3/4	13.33	14.67	2W4H
CSCU1-3450	40 X 60	40-3/4 X 60-3/4	16.67	16.67	2W5H
CSCU1-3454	40 X 64	40-3/4 X 64-3/4	17.78	17.33	2W5H
CSCU1-3460	40 X 72	40-3/4 X 72-3/4	20.00	18.67	2W6H
CSCU1-4040	48 X 48	48-3/4 X 48-3/4	16.00	16.00	2W4H
CSCU1-4050	48 X 60	48-3/4 X 60-3/4	20.00	18.00	2W5H
CSCU1-4054	48 X 64	48-3/4 X 64-3/4	21.33	18.67	2W5H
CSCU1-4060	48 X 72	48-3/4 X 72-3/4	24.00	20.00	2W6H
CSCU1-5040	60 X 48	60-3/4 X 48-3/4	20.00	18.00	3W4H
CSCU1-5050	60 X 60	60-3/4 X 60-3/4	25.00	20.00	3W5H
CSCU1-5054	60 X 64	60-3/4 X 64-3/4	26.67	20.67	3W5H
CSCU1-5060	60 X 72	60-3/4 X 72-3/4	30.00	22.00	3W6H

Note: All measurements are in inches.

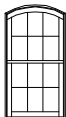

OPERATING RADIUS - SEGMENT HEAD DOUBLE-HUNG

Bookcodebd	Sizing		SqFt	LinFt	Divided Lites
	Frame Size	Rough Opening			Lite Pattern
CSDU1-2446	29-3/8 X 56	30-1/8 X 56-3/4	11.42	14.23	3W2H
CSDU1-2452	29-3/8 X 64	30-1/8 X 64-3/4	13.06	15.56	3W2H
CSDU1-2456	29-3/8 X 68	30-1/8 X 68-3/4	13.87	16.23	3W3H
CSDU1-2462	29-3/8 X 76	30-1/8 X 76-3/4	15.50	17.56	3W3H
CSDU1-2466	29-3/8 X 80	30-1/8 X 80-3/4	16.32	18.23	3W3H
CSDU1-2472	29-3/8 X 88	30-1/8 X 88-3/4	17.95	19.56	3W3H
CSDU1-2476	29-3/8 X 92	30-1/8 X 92-3/4	18.77	20.23	3W3H
CSDU1-2846	33-3/8 X 56	34-1/8 X 56-3/4	12.98	14.90	3W2H
CSDU1-2852	33-3/8 X 64	34-1/8 X 64-3/4	14.83	16.23	3W2H
CSDU1-2856	33-3/8 X 68	34-1/8 X 68-3/4	15.76	16.90	3W3H
CSDU1-2862	33-3/8 X 76	34-1/8 X 76-3/4	17.61	18.23	3W3H
CSDU1-2866	33-3/8 X 80	34-1/8 X 80-3/4	18.54	18.90	3W3H
CSDU1-2872	33-3/8 X 88	34-1/8 X 88-3/4	20.40	20.23	3W3H
CSDU1-2876	33-3/8 X 92	34-1/8 X 92-3/4	21.32	20.90	3W3H
CSDU1-3046	37-3/8 X 56	38-1/8 X 56-3/4	14.53	15.56	4W2H
CSDU1-3052	37-3/8 X 64	38-1/8 X 64-3/4	16.61	16.90	4W2H
CSDU1-3056	37-3/8 X 68	38-1/8 X 68-3/4	17.65	17.56	4W3H
CSDU1-3062	37-3/8 X 76	38-1/8 X 76-3/4	19.73	18.90	4W3H
CSDU1-3066	37-3/8 X 80	38-1/8 X 80-3/4	20.76	19.56	4W3H
CSDU1-3072	37-3/8 X 88	38-1/8 X 88-3/4	22.84	20.90	4W3H
CSDU1-3076	37-3/8 X 92	38-1/8 X 92-3/4	23.88	21.56	4W3H
CSDU1-3446	41-3/8 X 56	42-1/8 X 56-3/4	16.09	16.23	4W2H
CSDU1-3452	41-3/8 X 64	42-1/8 X 64-3/4	18.39	17.56	4W2H
CSDU1-3456	41-3/8 X 68	42-1/8 X 68-3/4	19.54	18.23	4W3H
CSDU1-3462	41-3/8 X 76	42-1/8 X 76-3/4	21.84	19.56	4W3H
CSDU1-3466	41-3/8 X 80	42-1/8 X 80-3/4	22.99	20.23	4W3H
CSDU1-346A	41-3/8 X 84	42-1/8 X 84-3/4	24.14	20.90	4W3H

Note: All measurements are in inches.



FIXED RADIUS - ROUND TOP UNITS

CASEMENT

Bookcode	Sizing		SqFt	LinFt	Divided Lites
	Frame Size	Rough Opening			Lite Pattern
TCCHR24	24 X 13-15/16	24-3/4 X 14-11/16	2.32	6.32	3 Spoke
TCCHR28	28 X 15-15/16	28-3/4 X 16-11/16	3.10	7.32	3 Spoke
TCCHR30	30 X 16-15/16	30-3/4 X 17-11/16	3.53	7.82	3 Spoke
TCCHR36	36 X 19-15/16	36-3/4 X 20-11/16	4.98	9.32	3 Spoke
TCCHR40	40 X 21-15/16	40-3/4 X 22-11/16	6.09	10.32	3 Spoke
TCCHR48	48 X 25-15/16	48-3/4 X 26-11/16	8.65	12.32	3 Spoke
TCCHR56	56 X 29-15/16	56-3/4 X 30-11/16	11.64	14.32	3 Spoke
TCCHR60	60 X 31-15/16	60-3/4 X 32-11/16	13.31	15.32	5 Spoke
TCCHR64	64 X 33-15/16	64-3/4 X 34-11/16	15.08	16.32	5 Spoke
TCCHR72	72 X 37-15/16	72-3/4 X 38-11/16	18.97	18.32	5 Spoke
TCCHR84	84 X 43-15/16	84-3/4 X 44-11/16	25.63	21.32	5 Spoke
TCCHR90	90 X 46-15/16	90-3/4 X 47-11/16	29.34	22.82	5 Spoke
TCCHR96	96 X 49-15/16	96-3/4 X 50-11/16	33.29	24.32	5 Spoke
TCCHR100 +	100 X 51-15/16	100-3/4 X 52-11/16	36.07	25.32	5 Spoke
TCCHR108 +	108 X 55-15/16	108-3/4 X 56-11/16	41.95	27.32	5 Spoke

DOUBLE-HUNG

Bookcode	Sizing		SqFt	LinFt	Divided Lites
	Frame Size	Rough Opening			Lite Pattern
TCDHR25	25-3/8 X 14-5/8	26-1/8 X 15-1/8	2.58	6.67	3 Spoke
TCDHR29	29-3/8 X 16-5/8	30-1/8 X 17-1/8	3.39	7.67	3 Spoke
TCDHR33	33-3/8 X 18-5/8	34-1/8 X 19-1/8	4.32	8.67	3 Spoke
TCDHR37	37-3/8 X 20-5/8	38-1/8 X 21-1/8	5.35	9.67	3 Spoke
TCDHR41	41-3/8 X 22-5/8	42-1/8 X 23-1/8	6.50	10.67	3 Spoke
TCDHR42	42-3/4 X 23-5/16	43-1/2 X 24-15/16	6.92	11.01	3 Spoke
TCDHR45	45-3/8 X 24-5/8	46-1/8 X 25-1/8	7.76	11.67	3 Spoke
TCDHR49	49-3/8 X 26-5/8	50-1/8 X 27-1/8	9.13	12.67	3 Spoke
TCDHR50	50-3/4 X 27-5/16	51-1/2 X 28-1/16	9.63	13.01	3 Spoke
TCDHR53	53-3/8 X 28-5/8	54-1/8 X 29-1/8	10.61	13.67	3 Spoke
TCDHR58	58-3/4 X 31-5/16	59-1/2 X 32-1/16	12.78	15.01	3 Spoke
TCDHR61	61-3/8 X 32-5/8	62-1/8 X 33-1/8	13.91	15.67	5 Spoke
TCDHR66	66-3/4 X 35-5/16	67-1/2 X 36-1/16	16.37	17.01	5 Spoke
TCDHR73	73-3/8 X 38-5/8	74-1/8 X 39-1/8	19.68	18.67	5 Spoke
TCDHR74	74-3/4 X 39-5/16	75-1/2 X 40-15/16	20.41	19.01	5 Spoke
TCDHR82	82-3/4 X 43-5/16	83-1/2 X 44-1/16	24.89	21.01	5 Spoke
TCDHR90	90-3/4 X 47-5/16	91-1/2 X 48-15/16	29.82	23.01	5 Spoke
TCDHR100 +	100-1/8 X 52	100-7/8 X 52-3/4	36.16	25.35	5 Spoke

+ Tempered Glass Standard

Note: All measurements are in inches.

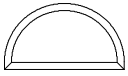

FIXED RADIUS - ROUND TOP UNITS

FRENCH VIEW

Bookcode	Sizing		SqFt	LinFt	Divided Lites
	Frame Size	Rough Opening			Lite Pattern
TCFVHR30	30-3/4 X 17-5/16	31-1/2 X 18-1/16	3.70	8.01	3 Spoke
TCFVHR32	32-3/4 X 18-5/16	33-1/2 X 19-1/16	4.16	8.51	3 Spoke
TCFVHR36	36-3/4 X 20-5/16	37-1/2 X 21-1/16	5.18	9.51	3 Spoke
TCFVHR47	47-1/2 X 25-11/16	48-1/4 X 26-7/16	8.47	12.20	5 Spoke
TCFVHR48	48-3/4 X 26-5/16	49-1/2 X 27-1/16	8.91	12.51	5 Spoke
TCFVHR49	49-1/2 X 26-11/16	50-1/4 X 27-7/16	9.17	12.70	5 Spoke
TCFVHR59	59-1/2 X 31-11/16	60-1/4 X 32-7/16	13.09	15.20	5 Spoke
TCFVHR61	61-1/2 X 32-11/16	62-1/4 X 33-7/16	13.96	15.70	5 Spoke
TCFVHR63	63-1/2 X 33-11/16	64-1/4 X 34-7/16	14.86	16.20	5 Spoke
TCFVHR65	65-1/2 X 34-11/16	66-1/4 X 35-7/16	15.78	16.70	5 Spoke
TCFVHR71	71-1/2 X 37-11/16	72-1/4 X 38-7/16	18.71	18.20	5 Spoke
TCFVHR73	73-1/2 X 38-11/16	74-1/4 X 39-7/16	19.75	18.70	5 Spoke
TCFVHR75	75-1/2 X 39-11/16	76-1/4 X 40-7/16	20.81	19.20	5 Spoke
TCFVHR95	95-1/2 X 49-11/16	96-1/4 X 50-7/16	32.95	24.20	5 Spoke
TCFVHR97	97-1/2 X 50-11/16	98-1/4 X 51-7/16	34.32	24.70	5 Spoke

HALLMARK

Bookcode	Sizing		SqFt	LinFt	Divided Lites
	Frame Size	Rough Opening			Lite Pattern
TCHPHR59	59-1/2 X 31-11/16	60-1/4 X 32-7/16	13.09	15.20	5 Spoke
TCHPHR63	63-1/2 X 33-11/16	64-1/4 X 34-7/16	14.86	16.20	5 Spoke
TCHPHR71	71-1/2 X 37-11/16	72-1/4 X 38-7/16	18.71	18.20	5 Spoke

Note: All measurements are in inches.

FIXED RADIUS - ELLIPTICAL UNITS

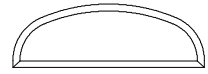

CASEMENT

Bookcode	Sizing		SqFt	LinFt	Divided Lites
	Frame Size	Rough Opening			Lite Pattern
TCCEL36	36 X 15-3/16	36-3/4 X 15-15/16	3.80	8.53	3 Spoke
TCCEL40	40 X 15-19/32	40-3/4 X 16-11/32	4.33	9.27	3 Spoke
TCCEL48	48 X 16-7/16	48-3/4 X 17-1/8	5.48	10.74	3 Spoke
TCCEL56	56 X 17-1/4	56-3/4 X 18	6.71	12.21	3 Spoke
TCCEL60	60 X 17-21/32	60-3/4 X 18-13/32	7.36	12.94	5 Spoke
TCCEL64	64 X 18-3/32	64-3/4 X 18-27/32	8.04	13.68	5 Spoke
TCCEL72	72 X 18-29/32	72-3/4 X 19-21/32	9.45	15.15	5 Spoke
TCCEL84	84 X 20-5/32	84-3/4 X 20-29/32	11.76	17.36	5 Spoke
TCCEL90	90 X 20-25/32	90-3/4 X 21-17/32	12.99	18.46	5 Spoke
TCCEL96	96 X 21-13/32	96-3/4 X 22-1/8	14.27	19.57	5 Spoke
TCCEL100 +	100 X 21-13/16	100-3/4 X 22-13/16	15.15	20.30	5 Spoke
TCCEL108 +	108 X 22-5/8	108-3/4 X 23-3/8	16.97	21.77	5 Spoke
TCCEL120 +	120 X 23-7/8	120-3/4 X 24-9/16	19.90	23.98	5 Spoke

DOUBLE-HUNG

Bookcode	Sizing		SqFt	LinFt	Divided Lites
	Frame Size	Rough Opening			Lite Pattern
TCDEL37	37-3/8 X 15-5/16	38-1/8 X 16-1/16	3.97	8.78	3 Spoke
TCDEL41	41-3/8 X 15-3/4	42-1/8 X 16-1/2	4.53	9.52	3 Spoke
TCDEL45	45-3/8 X 16-5/32	46-1/8 X 16-29/32	5.09	10.26	3 Spoke
TCDEL49	49-3/8 X 16-9/16	50-1/8 X 17-5/16	5.68	10.99	3 Spoke
TCDEL50	50-3/4 X 16 23/32	51-1/2 X 17-15/32	5.89	11.24	3 Spoke
TCDEL53	53-3/8 X 16 31/32	54-1/8 X 17-23/32	6.29	11.72	3 Spoke
TCDEL58	58-3/4 X 17-17/32	59-1/2 X 18-9/32	7.15	12.71	3 Spoke
TCDEL61	61-3/8 X 17-13/16	62-1/8 X 18-9/16	7.59	13.20	5 Spoke
TCDEL66	66-3/4 X 18-3/8	67-1/2 X 19-1/8	8.52	14.19	5 Spoke
TCDEL73	73-3/8 X 19-1/16	74-1/8 X 19-13/16	9.71	15.41	5 Spoke
TCDEL74	74-3/4 X 19-3/16	75-1/2 X 19-15/16	9.96	15.66	5 Spoke
TCDEL82	82-3/4 X 20-1/32	83-1/2 X 20-25/32	11.51	17.13	5 Spoke
TCDEL100 +	100-1/8 X 21-13/16	100-7/8 X 22-9/16	15.17	20.32	5 Spoke
TCDEL112 +	112-1/8 X 23-1/16	112-7/8 X 23-13/16	17.96	22.53	5 Spoke

+ Tempered Glass Standard

Note: All measurements are in inches.

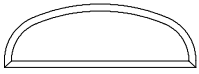

FIXED RADIUS - ELLIPTICAL UNITS

FRENCH VIEW

Bookcode	Sizing		SqFt	LinFt	Divided Lites
	Frame Size	Rough Opening			Lite Pattern
TCFVEL36	36-3/4 X 15-1/4	37-1/2 X 16	3.89	8.67	3 Spoke
TCFVEL47	47-1/2 X 16-3/8	48-1/4 X 17-1/8	5.40	10.65	3 Spoke
TCFVEL48	48-3/4 X 16-1/2	49-1/2 X 17-1/4	5.59	10.88	3 Spoke
TCFVEL49	49-1/2 X 16-9/16	50-1/4 X 17-9/16	5.69	11.01	3 Spoke
TCFVEL59	59-1/2 X 17-5/8	60-1/4 X 18-3/8	7.28	12.85	5 Spoke
TCFVEL61	61-1/2 X 17-13/16	62-1/4 X 18-9/16	7.61	13.22	5 Spoke
TCFVEL63	63-1/2 X 18-1/32	64-1/4 X 18-25/32	7.95	13.59	5 Spoke
TCFVEL65	65-1/2 X 18-1/4	66-1/4 X 19	8.30	13.96	5 Spoke
TCFVEL71	71-1/2 X 18-27/32	72-1/4 X 19-19/32	9.36	15.06	5 Spoke
TCFVEL73	73-1/2 X 19-1/16	74-1/4 X 19-13/16	9.73	15.43	5 Spoke
TCFVEL75	75-1/2 X 19-9/32	76-1/4 X 20-1/32	10.11	15.80	5 Spoke
TCFVEL95	95-1/2 X 21-11/32	96-1/4 X 22-3/32	14.16	19.47	5 Spoke
TCFVEL97	97-1/2 X 21-9/16	98-1/4 X 22-5/16	14.60	19.84	5 Spoke

HALLMARK

Bookcode	Sizing		SqFt	LinFt	Divided Lites
	Frame Size	Rough Opening			Lite Pattern
TCHPEL59	59-1/2 X 17-5/8	60-1/4 X 18-3/8	7.28	12.85	5 Spoke
TCHPEL63	63-1/2 X 18-1/32	64-1/4 X 18-25/32	7.95	13.59	5 Spoke
TCHPEL71	71-1/2 X 18-27/32	72-1/4 X 19-19/32	9.36	15.06	5 Spoke
TCHPEL106 +	106-7/8 X 22-17/32	107-5/8 X 23-9/32	16.72	21.57	5 Spoke

+ Tempered Glass Standard

Note: All measurements are in inches.

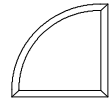

FIXED RADIUS - QUARTER ROUND UNITS

CASEMENT

Bookcode	Sizing		SqFt	LinFt	Divided Lites
	Frame Size	Rough Opening			Lite Pattern
TCCQR20	20 X 20	20-3/4 X 20-3/4	2.78	6.67	1 Spoke
TCCQR24	24 X 24	24-3/4 X 24-3/4	4.00	8.00	1 Spoke
TCCQR28	28 X 28	28-3/4 X 28-3/4	5.44	9.33	1 Spoke
TCCQR30	30 X 30	30-3/4 X 30-3/4	6.25	10.00	2 Spoke
TCCQR36	36 X 36	36-3/4 X 36-3/4	9.00	12.00	2 Spoke
TCCQR48	48 X 48	48-3/4 X 48-3/4	16.00	16.00	2 Spoke
TCCQR60	60 X 60	60-3/4 X 60-3/4	25.00	20.00	2 Spoke
TCCQR72	72 X 72	72-3/4 X 72-3/4	36.00	24.00	2 Spoke
TCCQR84 +	84 X 84	84-3/4 X 84-3/4	49.00	28.00	2 Spoke

DOUBLE-HUNG

Bookcode	Sizing		SqFt	LinFt	Divided Lites
	Frame Size	Rough Opening			Lite Pattern
TCDQR25	25-3/8 X 25-3/8	26-1/8 X 26-1/8	4.47	8.46	1 Spoke
TCDQR29	29-3/8 X 29-3/8	30-1/8 X 30-1/8	5.99	9.79	1 Spoke
TCDQR33	33-3/8 X 33-3/8	34-1/8 X 34-1/8	7.74	11.13	2 Spoke
TCDQR37	37-3/8 X 37-3/8	38-1/8 X 38-1/8	9.70	12.46	2 Spoke
TCDQR41	41-3/8 X 41-3/8	42-1/8 X 42-1/8	11.89	13.79	2 Spoke
TCDQR45	45-3/8 X 45-3/8	46-1/8 X 46-1/8	14.30	15.13	2 Spoke
TCDQR49	49-3/8 X 49-3/8	50-1/8 X 50-1/8	16.93	16.46	2 Spoke
TCDQR53	53-3/8 X 53-3/8	54-1/8 X 54-1/8	19.78	17.79	2 Spoke
TCDQR61	61-3/8 X 61-3/8	62-1/8 X 62-1/8	26.16	20.46	2 Spoke

+ Tempered Glass Standard

Note: All measurements are in inches.

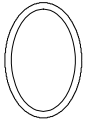

FIXED RADIUS - OVAL UNITS

Bookcode	Sizing		SqFt	LinFt
	Frame Size	Rough Opening		
TCOV2436	24 X 36	24-3/4 X 36-3/4	6.00	10.00
TCOV3048	30 X 48	30-3/4 X 48-3/4	10.00	13.00
TCOV3648	36 X 48	36-3/4 X 48-3/4	12.00	14.00
TCOV3660	36 X 60	36-3/4 X 60-3/4	15.00	16.00
TCOV3672	36 X 72	36-3/4 X 72-3/4	18.00	18.00
TCOV4872	48 X 72	48-3/4 X 72-3/4	24.00	20.00

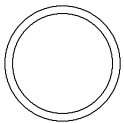

FIXED RADIUS - FULL ROUNDS

Bookcode	Sizing		SqFt	LinFt
	Frame Size	Rough Opening		
TCRD24	24 X 24	24-3/4 X 24-3/4	4.00	8.00
TCRD30	30 X 30	30-3/4 X 30-3/4	6.25	10.00
TCRD36	36 X 36	36-3/4 X 26-3/4	9.00	12.00
TCRD48	48 X 48	48-3/4 X 48-3/4	16.00	16.00
TCRD60	60 X 60	60-3/4 X 60-3/4	25.00	20.00
TCRD72	72 X 72	72-3/4 X 72-3/4	36.00	24.00
TCRD84 +	84 X 84	84-3/4 X 84-3/4	49.00	28.00

+ Tempered Glass Standard

Note: All measurements are in inches.

QUICK SPEC GUIDE

PRIMED FIXED RADIUS

SPECIFICATION	STANDARD FEATURES	OPTIONAL FEATURES <i>Some options may require additional lead times. Consult your JELD-WEN Sales Representative.</i>
EXTERIOR FINISH	S Primed	S Natural
INTERIOR FINISH	S Natural	S Primed or Painted White Finish S Stain - Fruitwood and Cider
SIZE	S Width: Standard Width & Heights to align with windows & patio doors 24, 26, 28, 24/36, 30, 32, 34	S Width: 12 to 96* in 1/8" increments S Height: 9 to 96* in 1/8" increments *some restrictions by shape
GLAZING	S Low-E Insulating Glass S Preserve® Protective Film	S Clear S Obscure S Low-E 366 S Neat Glass S Dual Low-E S Tints: Bronze, Gray, Green S Reflective Tints: Bronze, Gray S Tempered S High Altitude
GRILLES		S 7/8", 1-1/8" and 1-3/8" Removable Interior Grilles S 7/8", 1-1/8" and 1-3/8" Removable Full-Surround S 7/8" Removable Interior Vinyl Grille S 5/8" Flat; 22/32" and 1" Profiled GBG 7/8", 1-1/8", 1-3/8" and 2-1/8" SDL options: S 7/8", 1-1/8", 1-3/8" SDL with Removable Interior Full-Surround Wood Grille S 7/8", 1-1/8", 1-3/8" SDL with Permanently Applied Interior Wood Grille & Silver Shadow Bar S 2-1/8" Simulated Checkrail
EXTERIOR TRIMS	S Wood Brickmould	S 3-1/2" Flat Casing S 5-1/2" Flat Casing S 1x4 Flat Casing with Backband S No Brickmould
INTERIOR TRIM	S 2-1/4" Width Pine S WM 366, 356, 327	S 2-1/4" Width Oak S Custom Profiles Available in Pine
JAMB	S 4-9/16"	S Minimum: 4-9/16" S Maximum: 7-1/4" one piece S Maximum: 10-9/16" two piece

Note: All measurements are in inches.

QUICK SPEC GUIDE

PRIMED OPERATING RADIUS

SPECIFICATION	STANDARD FEATURES	OPTIONAL FEATURES <i>Some options may require additional lead times. Consult your JELD-WEN Sales Representative.</i>
EXTERIOR FINISH	S Primed	S Natural
INTERIOR FINISH	S Natural	S Primed or Painted White Finish S Stain - Fruitwood and Cider
SIZE	S Width: Segment Head Double-Hung & True Radius Single-Hung 29-3/8, 33-3/8, 37-3/8, 41-3/8 S Height: Segment Head Double-Hung 56, 64, 68**, 76 S Height: True Radius Single-Hung 58-3/8, 66-3/8, 70-3/8**, 78-3/8 **reverse cottage sash	S Special Widths not available S Height: 54 to 78 in 1/8" increments S Height: 58-3/8 to 78-3/8 in 1/8" increments
GLAZING	S Low-E Insulating Glass S Preserve® Protective Film	S Clear S Obscure S Low-E 366 S Neat Glass S Dual Low-E S Tints: Bronze, Gray, Green S Reflective Tints: Bronze, Gray S Tempered S High Altitude
HARDWARE	S Cam Lock S 2 Locks 3'0" and wider	
HARDWARE COLOR	S Chestnut Bronze	S White S Bright Brass S Desert Sand
SCREENS	S BetterVue™	S Aluminum Mesh S Fiberglass
SCREEN FRAME COLOR	S White	S Other clad colors
GRILLES		S 7/8", 1-1/8" and 1-3/8" Removable Interior Grilles S 7/8", 1-1/8" and 1-3/8" Removable Full-Surround S 7/8" Removable Interior Vinyl Grille S 5/8" Flat; 22/32" and 1" Profiled GBG 7/8", 1-1/8", 1-3/8" and 2-1/8" SDL options: S 7/8", 1-1/8", 1-3/8" SDL with Removable Interior Full-Surround Wood Grille S 7/8", 1-1/8", 1-3/8" SDL with Permanently Applied Interior Wood Grille & Silver Shadow Bar S 2-1/8" Simulated Checkrail
EXTERIOR TRIMS	S Wood Brickmould	S Heritage Casing S 3-1/2" Flat Casing S 4" Flat Casing S 5-1/2" Flat Casing S 1x4 Flat Casing with Backband S No Brickmould
JAMB	S Applied 4-9/16" or 6-9/16"	S Minimum: 4-9/16" S Maximum: 9-1/4" one piece S Maximum: 10-9/16" two piece

Note: All measurements are in inches.

QUICK SPEC GUIDE

PRIMED GEOMETRIC

SPECIFICATION	STANDARD FEATURES	OPTIONAL FEATURES <i>Some options may require additional lead times. Consult your JELD-WEN Sales Representative.</i>
EXTERIOR FINISH	S Primed	S Natural
INTERIOR FINISH	S Natural	S Primed or Painted White Finish S Stain - Fruitwood and Cider
SIZE	S Width: 9" to 120" (in 1/8" increments)* S Height: 9" to 120" (in 1/8" increments)* *see pages 10-18 and 10-19 for limitations	
GLAZING	S Low-E Insulating Glass S Preserve® Protective Film	S Clear S Obscure S Low-E 366 S Neat Glass S Dual Low-E S Tints: Bronze, Gray, Green S Reflective Tints: Bronze, Gray S Tempered S High Altitude
GRILLES		S 7/8", 1-1/8" and 1-3/8" Removable Interior Grilles S 7/8", 1-1/8" and 1-3/8" Removable Full-Surround S 7/8" Removable Interior Vinyl Grille S 5/8" Flat; 22/32" and 1" Profiled GBG 7/8", 1-1/8", 1-3/8" and 2-1/8" SDL options: S 7/8", 1-1/8", 1-3/8" SDL with Removable Interior Full-Surround Wood Grille S 7/8", 1-1/8", 1-3/8" SDL with Permanently Applied Interior Wood Grille & Silver Shadow Bar S 2-1/8" Simulated Checkrail
EXTERIOR TRIMS	S Wood Brickmould	S Heritage Casing S 3-1/2" Flat Casing S 5-1/2" Flat Casing S 1x4 Flat Casing with Backband S No Brickmould
JAMB	S Applied 4-9/16" or 6-9/16"	S Minimum: 3-15/16" S Maximum: 8-5/8" one piece S Maximum: 10-9/16" two piece

Note: All measurements are in inches.

FIXED RADIUS CUSTOM SIZING GUIDELINES

DIMENSIONS REQUIRED FOR STANDARD UNITS

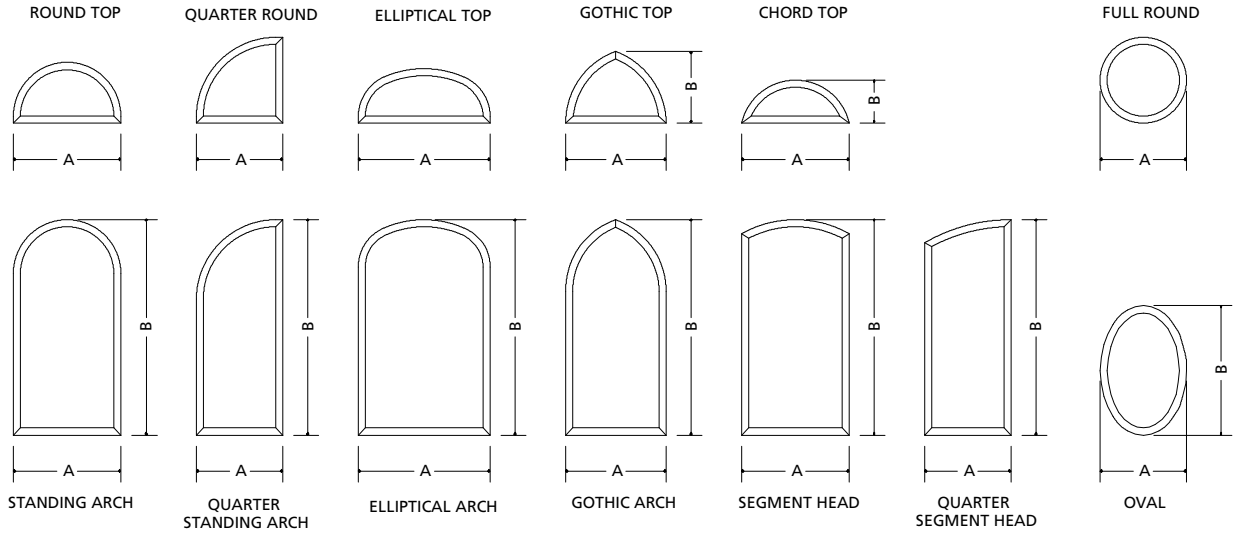

SIZE LIMITATIONS

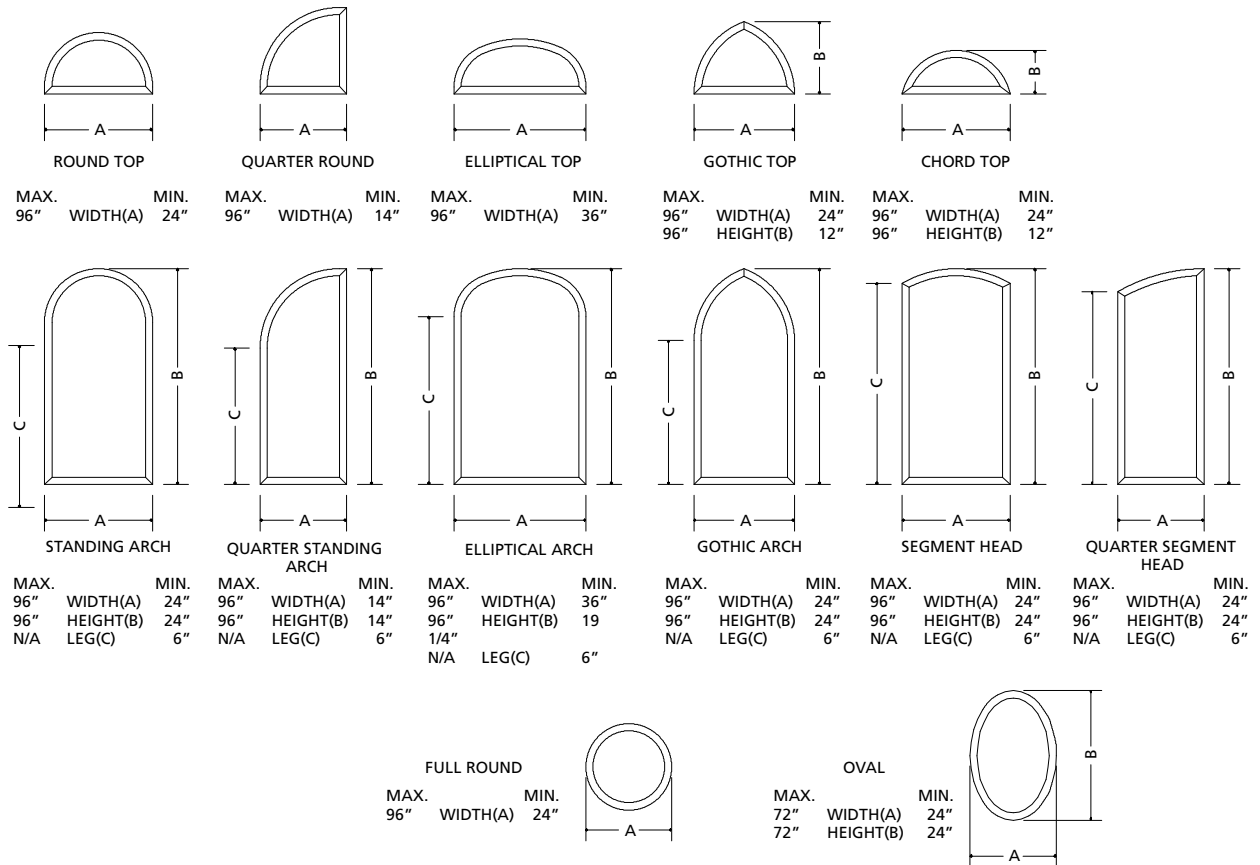

NOTE: Maximum square footage for one unit is 49 square feet.

Note: All measurements are in inches.

FIXED RADIUS DIMENSION CONVERSION CHART

		Width	Height
Rough Opening Dimension	Add	3/4"	1/2"
Flat Casing Dimension (Casement Family)	Add	6"	4"
Flat Casing Dimension (Double-Hung Family)	Add	5-5/8"	3-3/16"
Flat Casing Dimension (Sliding Window Family)	Add	4-7/16"	2-11/16"
Flat Casing Dimension (French View Patio Door Family)	Add	5-3/4"	2 7/8"
Flat Casing Dimension (Hallmark Door Family)	Add	4-13/16"	2-7/16"
Flat Casing Dimension (Traditional Door Family)	Add	5-11/16"	2-7/8"
Brickmould Dimension (Casement Family)	Add	3"	2-1/2"
Brickmould Dimension (Double-Hung Family)	Add	2-5/8"	1-11/16"
Brickmould Dimension (Sliding Window Family)	Add	1-7/16"	1 3/16"
Brickmould Dimension (French View Patio Door Family)	Add	2-3/4"	1-3/8"
Brickmould Dimension (Hallmark Door Family)	Add	1-13/16"	15/16"
Brickmould Dimension (Traditional Door Family)	Add	2-11/16"	1-3/8"
Glass Dimension	Subtract	3"	3"

NOTE: Full-Surround Grilles cannot be ordered separate from the unit. To ensure proper fit, they must be ordered at the same time as the unit.

EXAMPLE CUSTOM RADIUS GRILLES

FULL ROUNDS



PT-40



3X3



SH-80



OH-41



PT-41



SH-41

QUARTER ROUNDS



SH-10



SH-20



SH-30



OH-11



OH-22



SH-22

ROUND TOPS

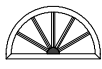

SH-50



SH-51

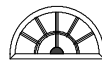

SHC-51



OH-51



OHC-51



GOTHIC

ELLIPTICAL TOPS



SH-30



SH-31



OH-31



OH-31
WITH SPIDER WEB



OH-31



COLONIAL

OVALS

Patterns shown below are available in removable wood grilles.

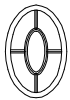

5 LITE OPEN HUB



8 LITE OPEN HUB



9 LITE OPEN HUB

SEGMENT HEADS

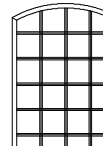

COLONIAL

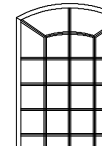

RENAISSANCE

Patterns shown below are available in simulated divided lites (SDL) and grilles between the glass.



5 LITE OPEN HUB



8 LITE OPEN HUB



9 LITE OPEN HUB

STANDING ARCHES

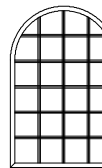

COLONIAL

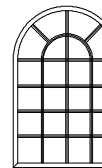

SUNBURST

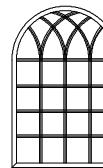

GOTHIC

Note: Lite patterns not available with divided lite options.

Note: All measurements are in inches.

FIXED RADIUS CURVED INTERIOR CASING

STANDARD INTERIOR WOOD CURVED CASING PROFILES

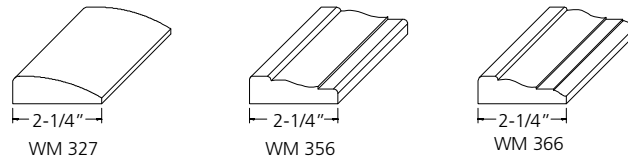

STANDARD INTERIOR WOOD CURVED CASING PROFILES

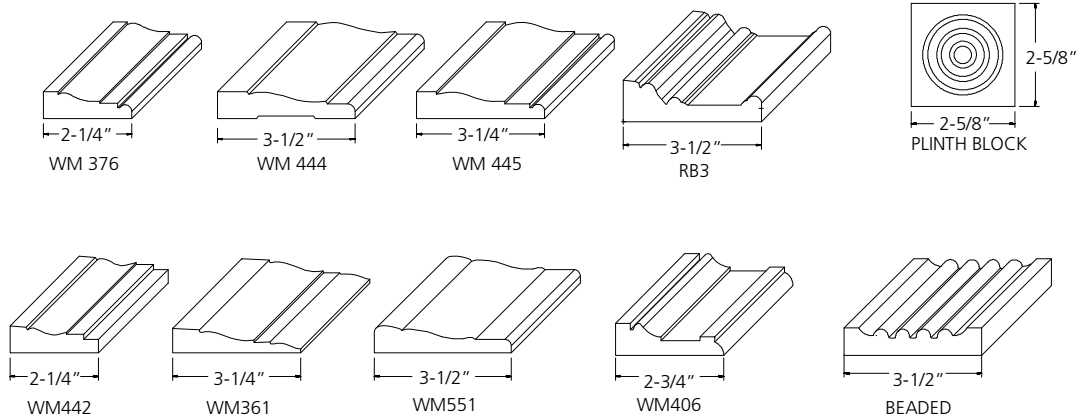

Note: All measurements are in inches.

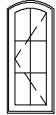

OPERATING RADIUS - SEGMENT HEAD CASEMENT

Bookcodebd	Sizing		SqFt	LinFt	Divided Lites
	Frame Size	Rough Opening			Lite Pattern
WSCU1-2040	24 X 48	24-3/4 X 48-3/4	8.00	12.00	2W4H
WSCU1-2050	24 X 60	24-3/4 X 60-3/4	10.00	14.00	2W5H
WSCU1-2054	24 X 64	24-3/4 X 64-3/4	10.67	14.67	2W5H
WSCU1-2060	24 X 72	24-3/4 X 72-3/4	12.00	16.00	2W6H
WSCU1-2640	30 X 48	30-3/4 X 48-3/4	10.00	13.00	3W4H
WSCU1-2650	30 X 60	30-3/4 X 60-3/4	12.50	15.00	3W5H
WSCU1-2654	30 X 64	30-3/4 X 64-3/4	13.33	15.67	3W5H
WSCU1-2660	30 X 72	30-3/4 X 72-3/4	15.00	17.00	3W6H
WSCU1-3440	40 X 48	40-3/4 X 48-3/4	13.33	14.67	2W4H
WSCU1-3450	40 X 60	40-3/4 X 60-3/4	16.67	16.67	2W5H
WSCU1-3454	40 X 64	40-3/4 X 64-3/4	17.78	17.33	2W5H
WSCU1-3460	40 X 72	40-3/4 X 72-3/4	20.00	18.67	2W6H
WSCU1-4040	48 X 48	48-3/4 X 48-3/4	16.00	16.00	2W4H
WSCU1-4050	48 X 60	48-3/4 X 60-3/4	20.00	18.00	2W5H
WSCU1-4054	48 X 64	48-3/4 X 64-3/4	21.33	18.67	2W5H
WSCU1-4060	48 X 72	48-3/4 X 72-3/4	24.00	20.00	2W6H
WSCU1-5040	60 X 48	60-3/4 X 48-3/4	20.00	18.00	3W4H
WSCU1-5050	60 X 60	60-3/4 X 60-3/4	25.00	20.00	3W5H
WSCU1-5054	60 X 64	60-3/4 X 64-3/4	26.67	20.67	3W5H
WSCU1-5060	60 X 72	60-3/4 X 72-3/4	30.00	22.00	3W6H

Note: All measurements are in inches.

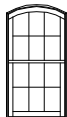

OPERATING RADIUS - SEGMENT HEAD DOUBLE-HUNG

Bookcodebd	Sizing		SqFt	LinFt	Divided Lites
	Frame Size	Rough Opening			Lite Pattern
WSDU1-2446	29-3/8 X 56	30-1/8 X 56-3/4	11.42	14.23	3W2H
WSDU1-2452	29-3/8 X 64	30-1/8 X 64-3/4	13.06	15.56	3W2H
WSDU1-2456	29-3/8 X 68	30-1/8 X 68-3/4	13.87	16.23	3W3H
WSDU1-2462	29-3/8 X 76	30-1/8 X 76-3/4	15.50	17.56	3W3H
WSDU1-2466	29-3/8 X 80	30-1/8 X 80-3/4	16.32	18.23	3W3H
WSDU1-2472	29-3/8 X 88	30-1/8 X 88-3/4	17.95	19.56	3W3H
WSDU1-2476	29-3/8 X 92	30-1/8 X 92-3/4	18.77	20.23	3W3H
WSDU1-2846	33-3/8 X 56	34-1/8 X 56-3/4	12.98	14.90	3W2H
WSDU1-2852	33-3/8 X 64	34-1/8 X 64-3/4	14.83	16.23	3W2H
WSDU1-2856	33-3/8 X 68	34-1/8 X 68-3/4	15.76	16.90	3W3H
WSDU1-2862	33-3/8 X 76	34-1/8 X 76-3/4	17.61	18.23	3W3H
WSDU1-2866	33-3/8 X 80	34-1/8 X 80-3/4	18.54	18.90	3W3H
WSDU1-2872	33-3/8 X 88	34-1/8 X 88-3/4	20.40	20.23	3W3H
WSDU1-2876	33-3/8 X 92	34-1/8 X 92-3/4	21.32	20.90	3W3H
WSDU1-3046	37-3/8 X 56	38-1/8 X 56-3/4	14.53	15.56	4W2H
WSDU1-3052	37-3/8 X 64	38-1/8 X 64-3/4	16.61	16.90	4W2H
WSDU1-3056	37-3/8 X 68	38-1/8 X 68-3/4	17.65	17.56	4W3H
WSDU1-3062	37-3/8 X 76	38-1/8 X 76-3/4	19.73	18.90	4W3H
WSDU1-3066	37-3/8 X 80	38-1/8 X 80-3/4	20.76	19.56	4W3H
WSDU1-3072	37-3/8 X 88	38-1/8 X 88-3/4	22.84	20.90	4W3H
WSDU1-3076	37-3/8 X 92	38-1/8 X 92-3/4	23.88	21.56	4W3H
WSDU1-3446	41-3/8 X 56	42-1/8 X 56-3/4	16.09	16.23	4W2H
WSDU1-3452	41-3/8 X 64	42-1/8 X 64-3/4	18.39	17.56	4W2H
WSDU1-3456	41-3/8 X 68	42-1/8 X 68-3/4	19.54	18.23	4W3H
WSDU1-3462	41-3/8 X 76	42-1/8 X 76-3/4	21.84	19.56	4W3H
WSDU1-3466	41-3/8 X 80	42-1/8 X 80-3/4	22.99	20.23	4W3H
WSDU1-346A	41-3/8 X 84	42-1/8 X 84-3/4	24.14	20.90	4W3H

Note: All measurements are in inches.



OPERATING RADIUS - TRUE RADIUS SINGLE-HUNG

Bookcode/bd	Sizing		SqFt	LinFt	Divided Lites
	Frame Size	Rough Opening			Lite Pattern
WRSU1-2446	29-3/8 X 56-7/16	29-3/8 X 57-3/16	11.51	14.30	3W2H
WRSU1-2452	29-3/8 X 64-7/16	29-3/8 X 65-3/16	13.14	15.64	3W2H
WRSU1-2456	29-3/8 X 68-7/16	29-3/8 X 69-3/16	13.96	16.30	3W3H
WRSU1-2462	29-3/8 X 76-7/16	29-3/8 X 77-3/16	15.59	17.64	3W3H
WRSU1-2466	29-3/8 X 80-7/16	29-3/8 X 81-3/16	16.41	18.30	3W3H
WRSU1-2472	29-3/8 X 88-7/16	29-3/8 X 89-3/16	18.04	19.64	3W3H
WRSU1-2476	29-3/8 X 92-7/16	29-3/8 X 93-3/16	18.86	20.30	3W3H
WRSU1-2846	33-3/8 X 56-7/16	33-3/8 X 57-3/16	13.08	14.97	3W2H
WRSU1-2852	33-3/8 X 64-7/16	33-3/8 X 65-3/16	14.93	16.30	3W2H
WRSU1-2856	33-3/8 X 68-7/16	33-3/8 X 69-3/16	15.86	16.97	3W3H
WRSU1-2862	33-3/8 X 76-7/16	33-3/8 X 77-3/16	17.72	18.30	3W3H
WRSU1-2866	33-3/8 X 80-7/16	33-3/8 X 81-3/16	18.64	18.97	3W3H
WRSU1-2872	33-3/8 X 88-7/16	33-3/8 X 89-3/16	20.50	20.30	3W3H
WRSU1-2876	33-3/8 X 92-7/16	33-3/8 X 93-3/16	21.42	20.97	3W3H
WRSU1-3046	37-3/8 X 56-7/16	37-3/8 X 57-3/16	14.65	15.64	4W2H
WRSU1-3052	37-3/8 X 64-7/16	37-3/8 X 65-3/16	16.72	16.97	4W2H
WRSU1-3056	37-3/8 X 68-7/16	37-3/8 X 69-3/16	17.76	17.64	4W3H
WRSU1-3062	37-3/8 X 76-7/16	37-3/8 X 77-3/16	19.84	18.97	4W3H
WRSU1-3066	37-3/8 X 80-7/16	37-3/8 X 81-3/16	20.88	19.64	4W3H
WRSU1-3072	37-3/8 X 88-7/16	37-3/8 X 89-3/16	22.95	20.97	4W3H
WRSU1-3076	37-3/8 X 92-7/16	37-3/8 X 93-3/16	23.99	21.64	4W3H
WRSU1-3446	41-3/8 X 56-7/16	41-3/8 X 57-3/16	16.22	16.30	4W2H
WRSU1-3452	41-3/8 X 64-7/16	41-3/8 X 65-3/16	18.51	17.64	4W2H
WRSU1-3456	41-3/8 X 68-7/16	41-3/8 X 69-3/16	19.66	18.30	4W3H
WRSU1-3462	41-3/8 X 76-7/16	41-3/8 X 77-3/16	21.96	19.64	4W3H
WRSU1-3466	41-3/8 X 80-7/16	41-3/8 X 81-3/16	23.11	20.30	4W3H
WRSU1-346A	41-3/8 X 84-7/16	41-3/8 X 85-3/16	24.26	20.97	4W3H

Note: All measurements are in inches.



FIXED RADIUS - ROUND TOP UNITS

CASEMENT

Bookcode	Sizing		SqFt	LinFt	Divided Lites
	Frame Size	Rough Opening			Lite Pattern
TWCHR24	24 X 13-15/16	24-3/4 X 14-11/16	2.32	6.32	3 Spoke
TWCHR28	28 X 15-15/16	28-3/4 X 16-11/16	3.10	7.32	3 Spoke
TWCHR30	30 X 16-15/16	30-3/4 X 17-11/16	3.53	7.82	3 Spoke
TWCHR36	36 X 19-15/16	36-3/4 X 20-11/16	4.98	9.32	3 Spoke
TWCHR40	40 X 21-15/16	40-3/4 X 22-11/16	6.09	10.32	3 Spoke
TWCHR48	48 X 25-15/16	48-3/4 X 26-11/16	8.65	12.32	3 Spoke
TWCHR56	56 X 29-15/16	56-3/4 X 30-11/16	11.64	14.32	3 Spoke
TWCHR60	60 X 31-15/16	60-3/4 X 32-11/16	13.31	15.32	5 Spoke
TWCHR64	64 X 33-15/16	64-3/4 X 34-11/16	15.08	16.32	5 Spoke
TWCHR72	72 X 37-15/16	72-3/4 X 38-11/16	18.97	18.32	5 Spoke
TWCHR84	84 X 43-15/16	84-3/4 X 44-11/16	25.63	21.32	5 Spoke
TWCHR90	90 X 46-15/16	90-3/4 X 47-11/16	29.34	22.82	5 Spoke
TWCHR96	96 X 49-15/16	96-3/4 X 50-11/16	33.29	24.32	5 Spoke
TWCHR100 +	100 X 51-15/16	100-3/4 X 52-11/16	36.07	25.32	5 Spoke
TWCHR108 +	108 X 55-15/16	108-3/4 X 56-11/16	41.95	27.32	5 Spoke

+ Tempered Glass Standard

DOUBLE-HUNG

Bookcode	Sizing		SqFt	LinFt	Divided Lites
	Frame Size	Rough Opening			Lite Pattern
TWDHR25	25-3/8 X 14-5/8	26-1/8 X 15-1/8	2.58	6.67	3 Spoke
TWDHR29	29-3/8 X 16-5/8	30-1/8 X 17-1/8	3.39	7.67	3 Spoke
TWDHR33	33-3/8 X 18-5/8	34-1/8 X 19-1/8	4.32	8.67	3 Spoke
TWDHR37	37-3/8 X 20-5/8	38-1/8 X 21-1/8	5.35	9.67	3 Spoke
TWDHR41	41-3/8 X 22-5/8	42-1/8 X 23-1/8	6.50	10.67	3 Spoke
TWDHR42	42-3/4 X 23-5/16	43-1/2 X 24-15/16	6.92	11.01	3 Spoke
TWDHR45	45-3/8 X 24-5/8	46-1/8 X 25-1/8	7.76	11.67	3 Spoke
TWDHR49	49-3/8 X 26-5/8	50-1/8 X 27-1/8	9.13	12.67	3 Spoke
TWDHR50	50-3/4 X 27-5/16	51-1/2 X 28-1/16	9.63	13.01	3 Spoke
TWDHR53	53-3/8 X 28-5/8	54-1/8 X 29-1/8	10.61	13.67	3 Spoke
TWDHR58	58-3/4 X 31-5/16	59-1/2 X 32-1/16	12.78	15.01	3 Spoke
TWDHR61	61-3/8 X 32-5/8	62-1/8 X 33-1/8	13.91	15.67	5 Spoke
TWDHR66	66-3/4 X 35-5/16	67-1/2 X 36-1/16	16.37	17.01	5 Spoke
TWDHR73	73-3/8 X 38-5/8	74-1/8 X 39-1/8	19.68	18.67	5 Spoke
TWDHR74	74-3/4 X 39-5/16	75-1/2 X 40-15/16	20.41	19.01	5 Spoke
TWDHR82	82-3/4 X 43-5/16	83-1/2 X 44-1/16	24.89	21.01	5 Spoke
TWDHR90	90-3/4 X 47-5/16	91-1/2 X 48-15/16	29.82	23.01	5 Spoke
TWDHR100 +	100-1/8 X 52	100-7/8 X 52-3/4	36.16	25.35	5 Spoke

+ Tempered Glass Standard

Note: All measurements are in inches.



FIXED RADIUS - ROUND TOP UNITS

FRENCH VIEW

Bookcode	Sizing		SqFt	LinFt	Divided Lites
	Frame Size	Rough Opening			Lite Pattern
TWVHR30	30-3/4 X 17-5/16	31-1/2 X 18-1/16	3.70	8.01	3 Spoke
TWVHR32	32-3/4 X 18-5/16	33-1/2 X 19-1/16	4.16	8.51	3 Spoke
TWVHR36	36-3/4 X 20-5/16	37-1/2 X 21-1/16	5.18	9.51	3 Spoke
TWVHR47	47-1/2 X 25-11/16	48 1/4 X 26-7/16	8.47	12.20	5 Spoke
TWVHR48	48-3/4 X 26-5/16	49-1/2 X 27-1/16	8.91	12.51	5 Spoke
TWVHR49	49-1/2 X 26-11/16	50-1/4 X 27-7/16	9.17	12.70	5 Spoke
TWVHR59	59-1/2 X 31-11/16	60-1/4 X 32-7/16	13.09	15.20	5 Spoke
TWVHR61	61-1/2 X 32-11/16	62-1/4 X 33-7/16	13.96	15.70	5 Spoke
TWVHR63	63-1/2 X 33-11/16	64-1/4 X 34-7/16	14.86	16.20	5 Spoke
TWVHR65	65-1/2 X 34-11/16	66-1/4 X 35-7/16	15.78	16.70	5 Spoke
TWVHR71	71-1/2 X 37-11/16	72-1/4 X 38-7/16	18.71	18.20	5 Spoke
TWVHR73	73-1/2 X 38-11/16	74-1/4 X 39-7/16	19.75	18.70	5 Spoke
TWVHR75	75-1/2 X 39-11/16	76-1/4 X 40-7/16	20.81	19.20	5 Spoke
TWVHR95	95-1/2 X 49-11/16	96-1/4 X 50-7/16	32.95	24.20	5 Spoke
TWVHR97	97-1/2 X 50-11/16	98-1/4 X 51-7/16	34.32	24.70	5 Spoke

HALLMARK

Bookcode	Sizing		SqFt	LinFt	Divided Lites
	Frame Size	Rough Opening			Lite Pattern
TWPHR59	59-1/2 X 31-11/16	60-1/4 X 32-7/16	13.09	15.20	5 Spoke
TWPHR63	63-1/2 X 33-11/16	64-1/4 X 34-7/16	14.86	16.20	5 Spoke
TWPHR71	71-1/2 X 37-11/16	72-1/4 X 38-7/16	18.71	18.20	5 Spoke

Note: All measurements are in inches.

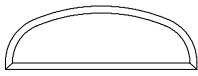

FIXED RADIUS - ELLIPTICAL UNITS

CASEMENT

Bookcode	Sizing		SqFt	LinFt	Divided Lites
	Frame Size	Rough Opening			Lite Pattern
TWCEL36	36 X 15-3/16	36-3/4 X 15-15/16	3.80	8.53	3 Spoke
TWCEL40	40 X 15-19/32	40-3/4 X 16-11/32	4.33	9.27	3 Spoke
TWCEL48	48 X 16-7/16	48-3/4 X 17-1/8	5.48	10.74	3 Spoke
TWCEL56	56 X 17-1/4	56-3/4 X 18	6.71	12.21	3 Spoke
TWCEL60	60 X 17-21/32	60-3/4 X 18-13/32	7.36	12.94	5 Spoke
TWCEL64	64 X 18-3/32	64-3/4 X 18-27/32	8.04	13.68	5 Spoke
TWCEL72	72 X 18-29/32	72-3/4 X 19-21/32	9.45	15.15	5 Spoke
TWCEL84	84 X 20-5/32	84-3/4 X 20-29/32	11.76	17.36	5 Spoke
TWCEL90	90 X 20-25/32	90-3/4 X 21-17/32	12.99	18.46	5 Spoke
TWCEL96	96 X 21-13/32	96-3/4 X 22-1/8	14.27	19.57	5 Spoke
TWCEL100 +	100 X 21-13/16	100-3/4 X 22-13/16	15.15	20.30	5 Spoke
TWCEL108 +	108 X 22-5/8	108-3/4 X 23-3/8	16.97	21.77	5 Spoke
TWCEL120 +	120 X 23-7/8	120-3/4 X 24-9/16	19.90	23.98	5 Spoke

+ Tempered Glass Standard

DOUBLE-HUNG

Bookcode	Sizing		SqFt	LinFt	Divided Lites
	Frame Size	Rough Opening			Lite Pattern
TWDEL37	37-3/8 X 15-5/16	38-1/8 X 16-1/16	3.97	8.78	3 Spoke
TWDEL41	41-3/8 X 15-3/4	42-1/8 X 16-1/2	4.53	9.52	3 Spoke
TWDEL45	45-3/8 X 16-5/32	46-1/8 X 16-29/32	5.09	10.26	3 Spoke
TWDEL49	49-3/8 X 16-9/16	50-1/8 X 17-5/16	5.68	10.99	3 Spoke
TWDEL50	50-3/4 X 16-23/32	51-1/2 X 17-15/32	5.89	11.24	3 Spoke
TWDEL53	53-3/8 X 16-31/32	54-1/8 X 17-23/32	6.29	11.72	3 Spoke
TWDEL58	58-3/4 X 17-17/32	59-1/2 X 18-9/32	7.15	12.71	3 Spoke
TWDEL61	61-3/8 X 17-13/16	62-1/8 X 18-9/16	7.59	13.20	5 Spoke
TWDEL66	66-3/4 X 18-3/8	67-1/2 X 19-1/8	8.52	14.19	5 Spoke
TWDEL73	73-3/8 X 19-1/16	74-1/8 X 19-13/16	9.71	15.41	5 Spoke
TWDEL74	74-3/4 X 19-3/16	75-1/2 X 19-15/16	9.96	15.66	5 Spoke
TWDEL82	82-3/4 X 20-1/32	83-1/2 X 20-25/32	11.51	17.13	5 Spoke
TWDEL100 +	100-1/8 X 21-13/16	100-7/8 X 22-9/16	15.17	20.32	5 Spoke
TWDEL112 +	112-1/8 X 23-1/16	112-7/8 X 23-13/16	17.96	22.53	5 Spoke

+ Tempered Glass Standard

Note: All measurements are in inches.

FIXED RADIUS - ELLIPTICAL UNITS

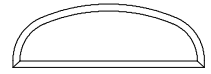

FRENCH VIEW

Bookcode	Sizing		SqFt	LinFt	Divided Lites
	Frame Size	Rough Opening			Lite Pattern
TWFFVEL36	36-3/4 X 15-1/4	37-1/2 X 16	3.89	8.67	3 Spoke
TWFFVEL47	47-1/2 X 16-3/8	48-1/4 X 17-1/8	5.40	10.65	3 Spoke
TWFFVEL48	48-3/4 X 16-1/2	49-1/2 X 17-1/4	5.59	10.88	3 Spoke
TWFFVEL49	49-1/2 X 16-9/16	50-1/4 X 17-9/16	5.69	11.01	3 Spoke
TWFFVEL59	59-1/2 X 17-5/8	60-1/4 X 18-3/8	7.28	12.85	5 Spoke
TWFFVEL61	61-1/2 X 17-13/16	62-1/4 X 18-9/16	7.61	13.22	5 Spoke
TWFFVEL63	63-1/2 X 18-1/32	64-1/4 X 18-25/32	7.95	13.59	5 Spoke
TWFFVEL65	65-1/2 X 18-1/4	66-1/4 X 19	8.30	13.96	5 Spoke
TWFFVEL71	71-1/2 X 18-27/32	72-1/4 X 19-19/32	9.36	15.06	5 Spoke
TWFFVEL73	73-1/2 X 19-1/16	74-1/4 X 19-13/16	9.73	15.43	5 Spoke
TWFFVEL75	75-1/2 X 19-9/32	76-1/4 X 20-1/32	10.11	15.80	5 Spoke
TWFFVEL95	95-1/2 X 21-11/32	96-1/4 X 22-3/32	14.16	19.47	5 Spoke
TWFFVEL97	97-1/2 X 21-9/16	98-1/4 X 22-5/16	14.60	19.84	5 Spoke

HALLMARK

Bookcode	Sizing		SqFt	LinFt	Divided Lites
	Frame Size	Rough Opening			Lite Pattern
TWHPEL59	59-1/2 X 17-5/8	60-1/4 X 18-3/8	7.28	12.85	5 Spoke
TWHPEL63	63-1/2 X 18-1/32	64-1/4 X 18-25/32	7.95	13.59	5 Spoke
TWHPEL71	71-1/2 X 18-27/32	72-1/4 X 19-19/32	9.36	15.06	5 Spoke
TWHPEL106 +	106-7/8 X 22-17/32	107-5/8 X 23-9/32	16.72	21.57	5 Spoke

+ Tempered Glass Standard

Note: All measurements are in inches.

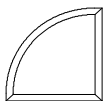

FIXED RADIUS - QUARTER ROUND UNITS

CASEMENT

Bookcode	Sizing		SqFt	LinFt	Divided Lites
	Frame Size	Rough Opening			Lite Pattern
TWCQR20	20 X 20	20-3/4 X 20-3/4	2.78	6.67	1 Spoke
TWCQR24	24 X 24	24-3/4 X 24-3/4	4.00	8.00	1 Spoke
TWCQR28	28 X 28	28-3/4 X 28-3/4	5.44	9.33	1 Spoke
TWCQR30	30 X 30	30-3/4 X 30-3/4	6.25	10.00	2 Spoke
TWCQR36	36 X 36	36-3/4 X 36-3/4	9.00	12.00	2 Spoke
TWCQR48	48 X 48	48-3/4 X 48-3/4	16.00	16.00	2 Spoke
TWCQR60	60 X 60	60-3/4 X 60-3/4	25.00	20.00	2 Spoke
TWCQR72	72 X 72	72-3/4 X 72-3/4	36.00	24.00	2 Spoke
TWCQR84 +	84 X 84	84-3/4 X 84-3/4	49.00	28.00	2 Spoke

+ Tempered Glass Standard

DOUBLE-HUNG

Bookcode	Sizing		SqFt	LinFt	Divided Lites
	Frame Size	Rough Opening			Lite Pattern
TWDQR25	25-3/8 X 25-3/8	26-1/8 X 26-1/8	4.47	8.46	1 Spoke
TWDQR29	29-3/8 X 29-3/8	30-1/8 X 30-1/8	5.99	9.79	1 Spoke
TWDQR33	33-3/8 X 33-3/8	34-1/8 X 34-1/8	7.74	11.13	2 Spoke
TWDQR37	37-3/8 X 37-3/8	38-1/8 X 38-1/8	9.70	12.46	2 Spoke
TWDQR41	41-3/8 X 41-3/8	42-1/8 X 42-1/8	11.89	13.79	2 Spoke
TWDQR45	45-3/8 X 45-3/8	46-1/8 X 46-1/8	14.30	15.13	2 Spoke
TWDQR49	49-3/8 X 49-3/8	50-1/8 X 50-1/8	16.93	16.46	2 Spoke
TWDQR53	53-3/8 X 53-3/8	54-1/8 X 54-1/8	19.78	17.79	2 Spoke
TWDQR61	61-3/8 X 61-3/8	62-1/8 X 62-1/8	26.16	20.46	2 Spoke

Note: All measurements are in inches.

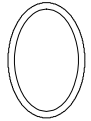

FIXED RADIUS - OVAL UNITS

Bookcode	Sizing		SqFt	LinFt
	Frame Size	Rough Opening		
TWOV2436	24 X 36	24-3/4 X 36-3/4	6.00	10.00
TWOV3048	30 X 48	30-3/4 X 48-3/4	10.00	13.00
TWOV3648	36 X 48	36-3/4 X 48-3/4	12.00	14.00
TWOV3660	36 X 60	36-3/4 X 60-3/4	15.00	16.00
TWOV3672	36 X 72	36-3/4 X 72-3/4	18.00	18.00
TWOV4872	48 X 72	48-3/4 X 72-3/4	24.00	20.00

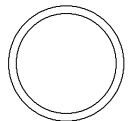

FIXED RADIUS - FULL ROUNDS

Bookcode	Sizing		SqFt	LinFt
	Frame Size	Rough Opening		
TWRD24	24 X 24	24-3/4 X 24-3/4	4.00	8.00
TWRD30	30 X 30	30-3/4 X 30-3/4	6.25	10.00
TWRD36	36 X 36	36-3/4 X 26-3/4	9.00	12.00
TWRD48	48 X 48	48-3/4 X 48-3/4	16.00	16.00
TWRD60	60 X 60	60-3/4 X 60-3/4	25.00	20.00
TWRD72	72 X 72	72-3/4 X 72-3/4	36.00	24.00
TWRD84 +	84 X 84	84-3/4 X 84-3/4	49.00	28.00

+ Tempered Glass Standard

Note: All measurements are in inches.